

DisplayMaker Legacy Mach 12

User Manual

Part Number 0706124 Rev B



Legal notices

© Copyright 2008 Hewlett-Packard Development Company, L.P.

The information contained herein is subject to change without notice. The only warranties for HP products and services are set forth in the express warranty statements accompanying such products and services. Nothing herein should be construed as constituting an additional warranty. HP shall not be liable for technical or editorial errors or omissions contained herein.

Printed in the US

For additional technical support and user documentation please refer to:

www.hp.com/go/graphicarts



Caution

SEVERE DAMAGE TO THE PRINTHEAD CARRIAGE CIRCUIT BOARD AND PRINTHEAD WILL OCCUR IF A PRINTHEAD IS REMOVED WHILE POWER IS SUPPLIED TO THE PRINTHEAD. Repairing this damage will require a service call and replacement of the printhead carriage circuit board and printhead at customer expense.

To avoid electrical damage to the printhead carriage circuit board and printhead:

Follow the instructions in the *DisplayMaker Mach 12 User Manual* to replace printheads.

DO NOT remove any printhead without first pressing the **Carriage** or **Prime** keys on the control panel. Pressing the Carriage key will move the printhead carriage to the center of the platen; pressing the Prime key will move the carriage out of the service station to the prime position. Pressing either key will cut power to the printheads, allowing you to safely remove and replace printheads.

DO NOT disable the “cover open” switches on the top cover or prime access door. When the printer detects that either of these doors is open, it cuts power to the printheads, making it safe to remove and replace printheads. If these switches are disabled, the printer can no longer detect whether the doors are open, making electrical damage more likely.

Revision Log

The following is a list of major changes and additions that have been made to this manual since it was first released.

See the accompanying *Release Notes* for specific changes to the software and hardware between manual updates.

Release Date Description

May 2001	Manual first released.
Mar 2002	Chapter 1: Added description of new dryer system. Chapter 2: Expanded description of ATTN messages. Documented many revisions to the menu. Chapter 3: Revised procedure "Selecting a Print Mode." Added new information about switching between ink sets. Revised procedure "Installing Ink for the First Time in a New Printer." Enhanced procedure "Replacing an Ink Tube" with new illustrations. Chapter 4: Replaced manual media feed calibration procedure. Chapter 5: Added top cover maintenance information. Appendix B: Added troubleshooting information on banding and using the isolation test print. Revised recovery procedure for error W-MD-4 Media Advance/Drive Too Slow.

Regulatory Statements

FCC-A

This equipment has been tested and found to comply with the limits for a Class A digital device, pursuant to Part 15 of the FCC Rules. These limits are designed to provide reasonable protection against harmful interference when the equipment is operated in a commercial environment. This equipment generates, uses, and can radiate radio frequency energy and, if not installed and used in accordance with the instruction manual, may cause harmful interference to radio communications. Operation of this equipment in a residential area is likely to cause harmful interference in which case the user will be required to correct the interference at his or her own expense.

This equipment must be installed exactly as instructed in this manual using only the components supplied. If a supplied component ever needs to be replaced, it must be replaced with the same part supplied by the manufacturer. It is your responsibility to follow these instructions in order to maintain compliance with the FCC regulations. Changes or modifications not expressly approved by ColorSpan Corporation could void your authority to operate this equipment. In particular, this device must be operated with shielded cables to maintain FCC compliance.

A booklet is available from the Federal Communications Commission entitled, *How to Identify and Resolve Radio-TV Interference Problems* (#004-000-00345-4). Write to the U.S. Government Printing Office, Washington, DC 20402.

DOC (Canada)

This digital apparatus does not exceed the Class A limits for radio noise for digital apparatus set out in the Radio Interference Regulations of the Canadian Department of Communications.

Normes de Sécurité (Canada)

Le présent appareil numérique n'émet pas de bruits radioélectriques dépassant les limites applicables aux appareils numériques de la Classe A prescrites dans le règlements sur le brouillage radioélectrique édictés par le Ministère des Communications du Canada.

Telecommunications Network Statement



The ColorSpan VideoNet port on this device is not intended to be connected to a public telecommunications network. Connection of this device to a public telecommunications network in a European Community Member State will be in violation of national law implementing Directive 91/263/EEC on the approximation of laws of the Member States concerning telecommunication terminal equipment, including the mutual recognition of their conformity.

Der VideoNet port ist nicht dafür vorgesehen an ein öffentliches Telefonnetz angeschlossen zu werden. Der Anschluß dieses Gerätes an ein öffentliches Telefonnetz in einem Mitgliedstaat der EU, verstößt gegen nationale Gesetze zur Ausführung der Direktive 91/263/EEC, die sich mit der Annäherung von Gesetzen von Mitgliedstaaten beschäftigt, betreffend Telekommunikationsanlagen und die gegenseitige Anerkennung ihrer Konformität.

About This Manual

Read this manual to unpack, set up, and use the ColorSpan DisplayMaker Mach 12 digital color printers.

- ◆ **Chapter 1** shows you how to unpack and assemble the printer, and introduces you to its main features.
- ◆ **Chapter 2** shows you how to use the control panel.
- ◆ **Chapter 3** shows you how to install ink and media.
- ◆ **Chapter 4** shows you how to calibrate the printer.
- ◆ **Chapter 5** shows you how to maintain the printer.
- ◆ **Appendix A** shows you how to troubleshoot common printing problems.
- ◆ **Appendix B** lists the printer's technical specifications.

For further information, refer to the following ColorSpan documentation:

- ◆ *Quick Start Guide - **START HERE*** to set up and install a brand new ColorMark print server, and connect and configure printers to it.
- ◆ *DisplayMaker Mach 12 Site Preparation Guide* - explains how to prepare your site for the printer's arrival and installation.
- ◆ *DisplayMaker Mach 12 Watch Me First* - a multimedia "how-to" guide on CD-ROM (available on VHS cassette from MacDermid ColorSpan Technical Services).
- ◆ *ColorSpan Print Server Documentation* - the *System Control User Guide* and *Printing Tools User Guides* shows you how to print and RIP files through the ColorSpan print server. If the printer is connected to a non-ColorSpan print server (RIP), refer to the documentation that accompanies the server.
- ◆ *Release Notes* and *Update Notes* - late-breaking information, update descriptions, and update instructions.

Further information about all ColorSpan products is also available over the Internet at the ColorSpan World Wide Web site at <http://www.colorsan.com>.

Conventions

This manual uses the following informational conventions:



Note A special technique or information that may help you perform a task or understand a process.

Hinweis Ein Hinweis beschreibt eine spezielle Technik zur Lösung einer Aufgabe oder enthält Informationen, die Ihnen eine Prozedur näher erläutern.



Caution Alerts you to something that has the potential to cause damage to hardware, software, or data.

Vorsicht Dieses Feld weist auf einen Umstand hin, der einen Hardware- oder Software-Schaden oder Datenverlust verursachen könnte.



WARNING Alerts you to something that has the potential to cause physical harm to you or others around you.

WARNUNG Eine Warnung auf weist auf einen Umstand hin, durch den Ihnen und anderen Personen ein physischer Schaden erwachsen könnte.

Other WARNING symbols used:



Electrical Hazard

Vorsicht steht unter Spannung



Lifting Hazard

Vorsicht beim Anheben

TABLE OF CONTENTS

Revision Log.....	iv
Regulatory Statements.....	v
FCC-A.....	v
DOC (Canada).....	v
Telecommunications Network Statement.....	vi
About This Manual	vii
Conventions.....	viii

1 Getting Started

Operating Requirements	1-2
Electrical.....	1-2
Environmental.....	1-2
Important Operating Notes.....	1-3
Safety Warnings.....	1-4
Unpacking and Assembly	1-5
Unpacking.....	1-5
Parts List.....	1-6
Stand Assembly.....	1-7
Final Assembly	1-8
Connecting to Power.....	1-13
Connecting to the Print Server	1-14
Power-Up Sequence.....	1-15
What's Next?.....	1-15
Workflow Overview	1-16
Parts Overview	1-17
Special Features	1-21
Performance Features	1-21
Ease-Of-Use Features	1-21

2 Using the Control Panel

Overview.....	2-2
Ready Screen.....	2-2
Front Page.....	2-2
Menu.....	2-2
User Assistance.....	2-3
Front Page.....	2-5
Navigation Keys	2-9
Menu.....	2-10
Calibrate Printer.....	2-10
Printer Configuration	2-11

Print Settings	2-11
Printer Options.....	2-13
Reset All Defaults	2-15
Service Printer	2-16
User Diagnostics	2-16
Service Tests	2-16
Calibrations	2-17
Home Head.....	2-17
Measure Media Width	2-17
New Carriage	2-17
Prime Bars	2-17
Disable Media Sensor	2-18
Warnings & Actions	2-18
Menu Tree.....	2-19
Front Page.....	2-19
Calibrate Printer.....	2-19
Configure Printer.....	2-20
Service Printer	2-20
Warnings & Actions	2-21

3 Installing Ink and Media

Variable Mode Printing.....	3-2
Ink System Overview.....	3-4
Spare Ink and Printheads.....	3-6
Selecting a Print Mode.....	3-7
Switching Between Ink Sets.....	3-10
Installing Ink for the First Time in a New Printer.....	3-12
Replacing Ink System Components	3-17
Replacing an Ink Reservoir in an Idle Printer.....	3-17
Replacing an Ink Reservoir During Printing (“Hot Swapping”).....	3-18
Replacing a Printhead	3-19
Replacing An Ink Tube	3-20
Loading Media.....	3-24
Loading 72-Inch Media	3-29
Takeup Options.....	3-30
Linearization.....	3-30
Dryer Operation.....	3-31
Cutting and Unloading Media.....	3-32

4 Calibrating the Printer

AutoSet.....	4-2
Manual Calibrations	4-3
Media Feed Calibration	4-4
34-Inch/12-inch Calibration	4-5
Double Lines Calibration	4-6
Manual Bidirectional Registration	4-7
Manual Head Registration	4-10
Manual Jet Mapping.....	4-13
Report Individual Bad Jets	4-15
Clear Individual Bad Jets	4-16
View Current Bad Jets.....	4-16
Clear All Bad Jets.....	4-17
Jet Status Lines.....	4-18
Zero Registration Data	4-18
Auto Calibrations	4-19
AutoTune	4-20
Quality Check Mode.....	4-20
Calibration Summary	4-21
Linearization	4-23

5 Maintaining the Printer

Maintenance Schedule	5-2
Cleaning Ink Jets.....	5-3
Evaluating Printhead Performance After Cleaning	5-4
Cleaning Jet Outs.....	5-4
Cleaning the Service Station	5-5
Printing Prime Bars	5-7
Manual Priming	5-8
Cleaning the Top Cover.....	5-10
Purging the Printheads	5-11
Cleaning the Encoder	5-13
Cleaning the Carriage Rail.....	5-14

A Technical Specifications

Specifications	A-2
Supported Ink and Media.....	A-4
Supplies and Accessories	A-5

B Troubleshooting

Troubleshooting Checklist	B-2
Diagnostics.....	B-4
Banding.....	B-9
Stitch Banding.....	B-9
Edge Banding.....	B-9
Supply-Loop Banding	B-10
Texture Banding.....	B-11
Swath Edge Banding.....	B-11
MacDermid ColorSpan Technical Services.....	B-12
Help From Your Reseller	B-12
Help From ColorSpan	B-12
If All Else Fails.....	B-12

Index

CHAPTER 1

Getting Started

This chapter shows you how to get started using your printer. It includes these topics:

- ◆ Operating Requirements (page 1-2)
- ◆ Unpacking and Assembly (page 1-5)
- ◆ Workflow Overview (page 1-16)
- ◆ Parts Overview (page 1-17)
- ◆ Special Features (page 1-21)

Operating Requirements

Choose a location for the printer before you unpack it. Keep the following requirements in mind:

Electrical

- ◆ See “Connecting to Power” on page 1-13 for detailed power requirements.
- ◆ Use the supplied power cords. Plug them directly into a grounded electrical outlet. Do not lengthen either power cord with an extension cord; the resulting voltage drop could damage the printer.
- ◆ The supply cord for the primary dryer serves as a disconnect. The socket-outlet shall be installed near the equipment and shall be easily accessible.
- ◆ Make sure the line voltage does not vary more than 10 percent from the voltage marked on the back of the printer. Install a voltage regulator or similar device if the power source is not stable.
- ◆ Unplug the printer during power failures. Wait for the power to return before plugging it back in.
- ◆ Connect the print server to a separate circuit from the printer.

Environmental

- ◆ Make sure the room is well ventilated, with a temperature between 60° and 90° F (16° to 32° C). The relative humidity should be between 30 and 60 percent, non-condensing. Optimal printing and drying occurs within these ranges. Printing slows automatically to aid drying in high humidity conditions.
- ◆ Store media and ink in an area with similar temperature and humidity conditions as the printer.
- ◆ Keep the ventilation slots under the dryer tube free of any blockage. This will allow the output dryer fans to properly dry the printer output.
- ◆ Locate the printer close enough to the print server (RIP) so that they can be connected with the required cable.
- ◆ Locate the printer on a flat, level surface.
- ◆ Locate the printer where its normal operating noise will not disturb quiet work areas.

- ◆ DO NOT install the printer near humidifiers, refrigerators, fans, water faucets, heaters or similar equipment.
- ◆ DO NOT install the printer in areas where the temperature changes abruptly, such as near air conditioners or in the path of direct sunlight.
- ◆ DO NOT expose the printer to flames, dust or solvent chemicals.

Refer to Appendix B for detailed specifications.

Important Operating Notes

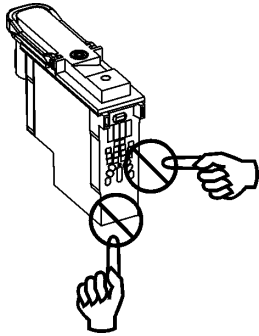

- ◆ Wear cotton gloves (provided with each roll of ColorSpan media) when loading media to prevent fingerprints that could show after printing.
- ◆ Protect the media at all times from creases and tears, and ensure that the media is cut cleanly. Do not rest or store a media roll on end, or you could cause edge creases that could strike the printheads during printing.
- ◆ Always use a lint-free cloth moistened with plain water to clean the printhead.
- ◆ DO NOT touch the printhead's ink jet nozzles (the metal plate on the bottom of the printhead) with your fingers. Any contaminants could clog the ink jet nozzles.
- ◆ DO NOT touch the electrodes on the back of the ink printhead. This could result in a faulty electrical connection, which would cause jets to misfire.
- ◆ DO NOT clean the printhead surfaces with a dry cloth or paper towel.
- ◆ DO NOT set heavy objects on the power cord or printer cable; do not bend the cables or force them into contorted positions.
- ◆ DO NOT place heavy objects anywhere on the printer.

Safety Warnings



WARNING WITH THE POWER SWITCH IN THE OFF POSITION, POWER MAY STILL BE SUPPLIED TO THE PRINTER COMPONENTS. To completely cut power from the printer, you must unplug the power cords from the power outlets.

WARNUNG WENN DER NETZSCHALTER IN OFF POSITION STEHT, WIRD DEN KOMPONENTEN TROTZDEM STROM ZUGEFÜHRT. Um den Drucker komplett stromfrei zu machen, müssen Sie den Netzstecker ziehen.



WARNING The printer is too heavy to be lifted safely by one person. At least two persons are required to lift the printer.

WARNUNG Der Drucker ist zu schwer für eine Person. Mindestens 2 Personen sind erforderlich um den Drucker anzuheben.



WARNING THE PRINTER ELECTRONICS ASSEMBLY CONTAINS A LITHIUM BATTERY DEVICE. THERE IS A DANGER OF EXPLOSION IF THE BATTERY IS INCORRECTLY REPLACED. The battery must be replaced only by ColorSpan authorized personnel, and must be replaced only with the same or equivalent type. Dispose of this lithium battery device in accordance with local, state (or province), and Federal (or country) solid waste requirements.

WARNUNG DIE ELEKTRONIK DES DRUCKERS ENTHÄLT EINE LITHIUM BATTERIE. ES BESTEHT EXPLOSIONSGEFAHR WENN DIESE UNSACHGEMÄSS AUSGEWECHSELT WIRD. Die Batterie darf nur durch einen ColorSpan autorisierten Techniker ausgewechselt werden und muss mit dem gleichen oder einem gleichwertigen Typ Batterie ersetzt werden. Bitte entsorgen Sie die Lithium Batterie gemäss Ihren Landes- oder Bundesgesetzen.



WARNING Moving parts. Keep fingers away from media path.

WARNUNG Bewegliche Teile, Verletzungsgefahr.

Unpacking and Assembly

This procedure assumes that the printer is in its final location. See the *Site Preparation Guide* for moving and unpacking hints.



WARNING The printer is too heavy to be lifted safely by one person. At least two persons are required to lift the printer.



WARNUNG Der Drucker ist zu schwer für eine Person. Mindestens 2 Personen sind erforderlich um den Drucker anzuheben.



Note If you will be installing a ColorSpan Print Server, set it up now and power it on. This will allow the server to perform its automatic one-time new system check while you unpack and assemble the printer.

Unpacking

1. The printer is delivered to your site packed in one cardboard box, attached to a plywood platform on two wooden pallets. Examine the shipping packaging for shipping damage.

Report any damage or apparent rough handling immediately to the shipper.

2. Remove the Unpacking and Assembly diagram, Watch Me First CD-ROM, and other documents from the outside of the box, and set them aside for reference.

You can use the Unpacking and Assembly diagram for reference during the unpacking and assembly process. The Watch Me First CD-ROM contains useful “getting started” information, including a demonstration of unpacking, assembly, and setup.

3. Remove the bands that secure the box to the pallet and open the top flaps of the box.
4. Carefully cut the corners of the outer box and remove it from the pallet.
5. Remove the packing material from the printer.
6. Remove the stand crossbar, which is packed on top of the printer.
7. Remove the ink tray boxes, stand leg boxes, and accessory boxes, which are packed together in the center of the pallet.
8. Remove the cardboard shipping end caps from each end of the printer.

9. Remove the media spools, which are packed together under the printer module.

Do not remove the printer module from the pallet at this time. The printer rests on two shipping supports. You will use these supports and two assembly supports to help assemble the printer.



Note Replacement shipping packaging and instructions are available from MacDermid ColorSpan Technical Services (phone: 800-925-0563).

10. Refer to the following list to verify that you received all of the parts and accessories.

Notify ColorSpan immediately if you are missing any of the components listed below.

Parts List

Main Box	Outside of Box: <ul style="list-style-type: none">◆ "Watch Me First" CD-ROM◆ Unpacking & Assembly Diagram◆ Declaration of Conformity Inside of Box: <ul style="list-style-type: none">◆ Printer Module◆ (1) Stand crossbar◆ (2) Media spools with collets◆ (1) Stand leg box◆ (1) Ink tray box◆ (1) Accessory box
Stand Leg Box	◆ (2) Stand legs
Ink Tray Box	◆ (2) Ink trays
Accessory Box	<ul style="list-style-type: none">◆ (18) Black Phillips head screws◆ (4) Silver Phillips head screws◆ (2) Red-headed bolts◆ (1) Service station◆ (1) Ink maintenance kit: manual priming bulb, purge clip, drain bottle◆ (1) Fill system assembly◆ (2) Spare ink tubes◆ (11) Color Map print mode cards◆ (1) White point reference chip◆ (1) Screwdriver◆ (1) Hex wrench◆ (1) VideoNet or Ethernet cable◆ (3) U.S. domestic power cords◆ (2) European power cords◆ (3) International power plug adapters◆ Documentation, warranty, and software license agreement

Stand Assembly

1. Locate the stand legs **1** and **2**, and the crossbar **3**.
2. Using the Phillips head screwdriver and eight of the screws provided, assemble the stand.

Start by positioning the two stand legs upright, at approximately the width of the crossbar. Align the holes on the crossbar with the holes in the stand legs, and secure them with the screws.

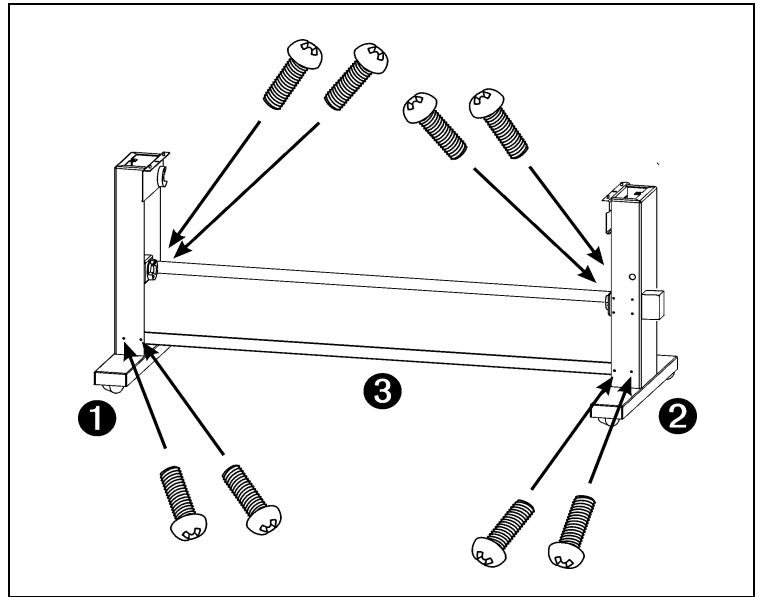

Fig. 1-1. Stand assembly

Final Assembly

1. Remove the two red-headed bolts from the right-hand shipping support.

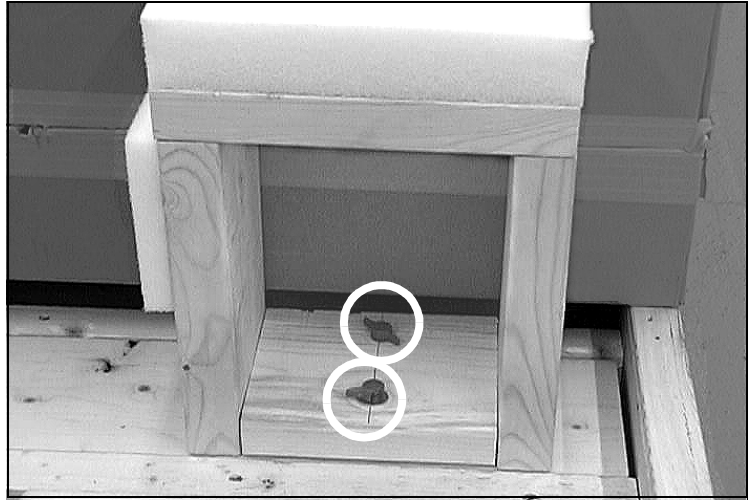

Fig. 1-2. Remove the red-headed bolts

2. Locate the assembly supports ④.

The assembly supports are mirror images of each other; the foam pad should be positioned toward the ends of the printer.

3. Align the assembly supports ④ with the shipping supports ⑤, at the rear of the pallet as shown.

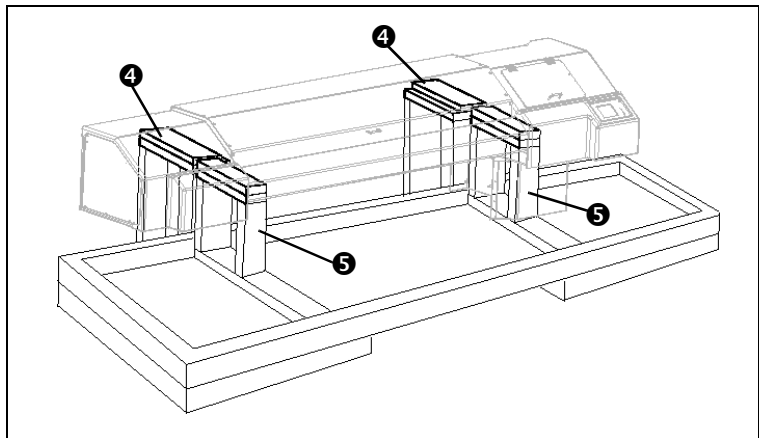

Fig. 1-3. Assembly supports ④, shipping supports ⑤

- Thread one of the red-headed bolts that you removed from the shipping support ⑤ through the assembly support into the pallet.

The pallet contains a threaded nut that will accept the bolt. Tighten the bolt hand-tight.

- Attach the other assembly support to the pallet with the other red-headed bolt.



WARNING The printer is too heavy to be lifted safely by one person. At least two persons are required to lift the printer.



WARNUNG Der Drucker ist zu schwer für eine Person. Mindestens 2 Personen sind erforderlich um den Drucker anzuheben.

- With two to four persons, roll the printer onto its back, on the assembly supports.

The printer is now resting entirely on the assembly supports. The right-hand shipping support is trapped with the printer and will roll with it.

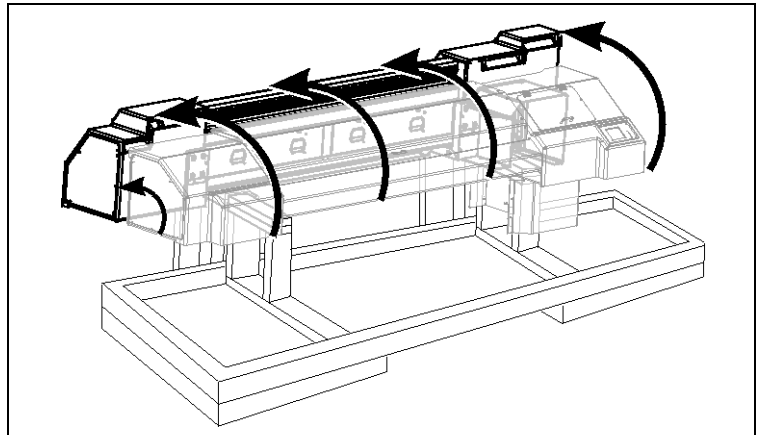

Fig. 1-4. Roll the printer onto its back

7. Remove the right-hand shipping support from the printer, and bolt it to the pallet as shown, using the two red-headed bolts provided. **Do not remove the bolts from the rear supports.**

Note that the “tower” of the support is now at the front of the pallet.

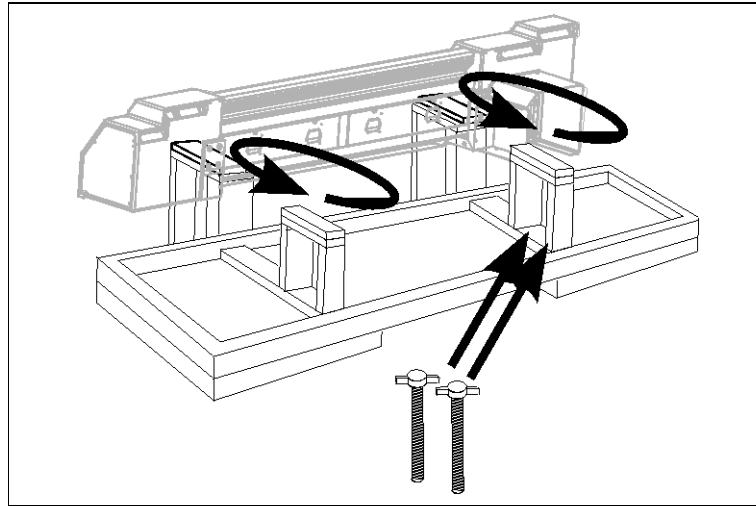

Fig. 1-5. Shipping supports reversed and bolted

8. Lift the left-hand shipping support from the pallet, reverse it, and replace it into its guides on the pallet.

The “tower” of the support is now at the front of the pallet.

9. Gently tip the assembled stand on its back, and set it down on top of the shipping supports as shown in Fig. 1-6.

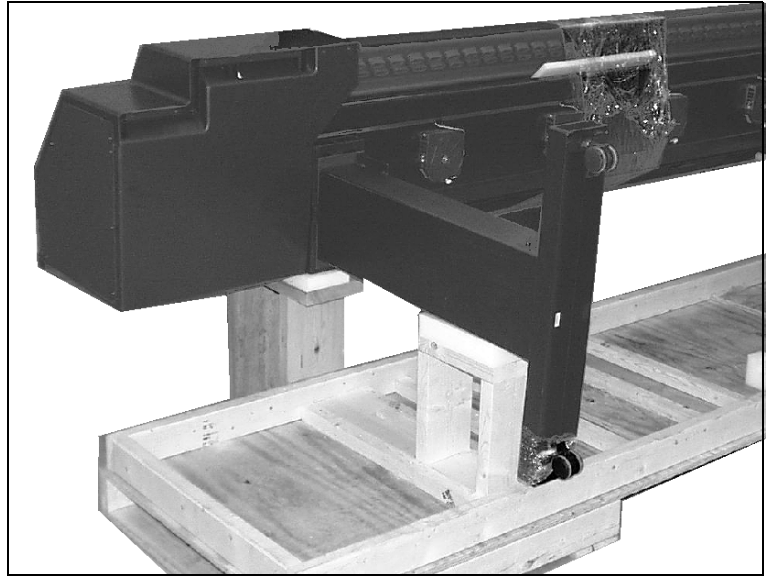

Fig. 1-6. Assemble the printer module and stand

10. Using the two silver Phillips head screws provided, attach the stand to printer module.
The silver screws are required to establish an electrical ground connection between the printer and stand.
11. Press the caster locks down to prevent the printer from rolling.
12. With the aid of one or more persons, carefully rotate the assembled printer upright.
Be ready for the printer's center of gravity to shift, so you can tip the printer to its upright position in a controlled manner.
13. Unlock the casters and roll the printer to its final location. Then lock down the casters.
14. Locate the printer on a flat, level floor, with all four wheels of the stand resting stationary on the floor. The printer must remain stationary and level for proper ink flow and best print quality.
15. Locate and connect the profiler docking station cable on the left end of the printer, and connect it from the left-hand ink tray to the port on the printer.

16. Locate and connect the profiler docking station cable from the right-hand ink tray to the port on the printer.
17. Using ten of the screws provided, attach the ink trays ③ and ④.

The right and left trays are mirror images of each other. Position the trays so that the inks load from the front.

Insert and tighten the screws most of the way, insert and drop the trays into place onto the screws, then tighten the screws the rest of the way.

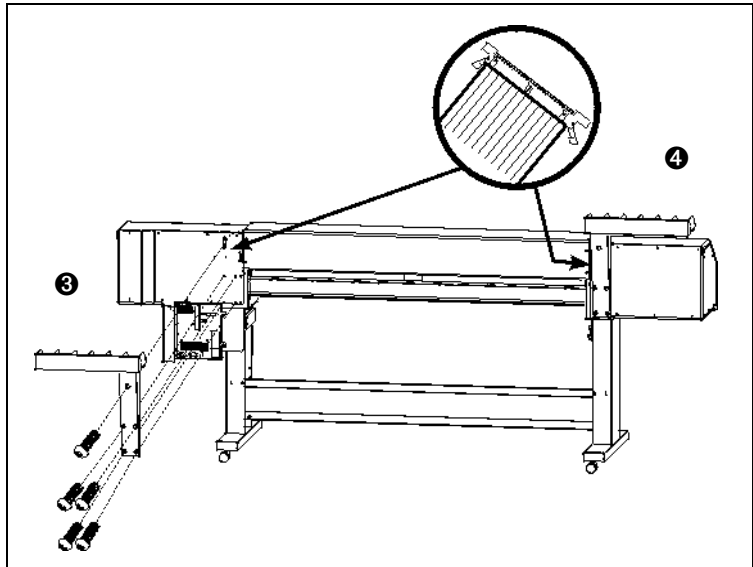

Fig. 1-7. Attach the ink trays,
connect docking station cable

18. Remove the shipping bands from the long black chain connected to the printhead carriage.
19. Remove the foam block that immobilizes the carriage for shipping.
20. Place the white point reference chip into the circular cutout on the platen, near the left end.

To reach the white point cutout, you will need to reach inside the left endcap.

21. Install the service station by inserting it into the rectangular cutout inside the right endcap (behind the control panel).

Position the service station so that the edge with the word "FRONT" is closest to the front of the printer. Slide the service station fully to the left end of the cutout.

22. Join the connector on the twisted wires from the takeup motor to the connector on the electronics assembly.

The connector on the electronics assembly is on the side of the electronics enclosure, near the takeup spool bracket.

Connecting to Power

The printer has separate power inputs for the printer and dryer heaters. Each cord will only fit into its corresponding inlet on the printer. The printer can be operated with one or both inlets connected to power. See Appendix A, Technical Specifications, or refer to the *Site Preparation Guide*, for detailed power requirements.

Refer to Fig. 1-8 for the locations of the printer power inlets.

The print server may be connected to the same circuit as the printer if the circuit's amperage is sufficient for both devices. Refer to the print server's documentation for its amperage requirement. Consult a qualified electrician if you have any doubt as to how the circuits in your facility can accommodate the printer and print server.



WARNING WITH THE POWER SWITCH IN THE OFF POSITION, POWER MAY STILL BE SUPPLIED TO THE PRINTER COMPONENTS. To completely cut power from the printer, you must unplug the power cords from the power outlets.



WARNUNG WENN DER NETZSCHALTER IN OFF POSITION STEHT, WIRD DEN KOMPONENTEN TROTZDEM STROM ZUGEFÜHRT. Um den Drucker komplett stromfrei zu machen, müssen Sie den Netzstecker ziehen.

Connecting to the Print Server

Connect the printer to the print server with the included VideoNet (for ColorSpan print servers) or Ethernet cable (non-ColorSpan RIPs). See Fig. 1-8.

Refer to the print server (RIP) documentation for further instructions on connecting the printer to the print server.

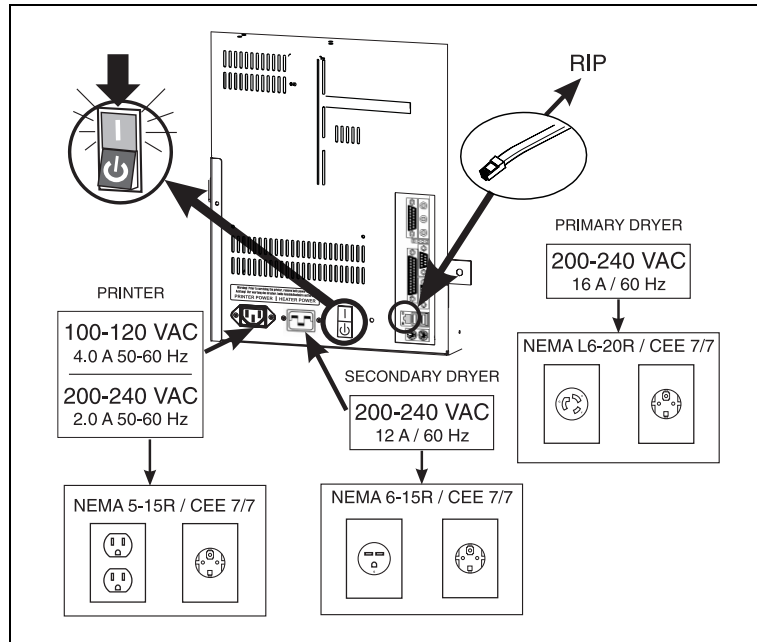

Fig. 1-8. Power and RIP connections

Power-Up Sequence

Turn on the power switch to observe the typical power-up sequence:

1. The control panel backlight illuminates. Move the contrast lever (located to the right of the control panel screen) up and down until the control panel graphics and messages are easily visible.
2. The printer runs a series of self-tests, and reports any errors it finds.
3. The camera searches for the location of the installed media's home and far edges. If media is installed, this data tells the printer the width of the installed media. If no media is installed, the printer will prompt the user to load media when the next print job is sent to the printer.
4. The control panel displays the status screen.

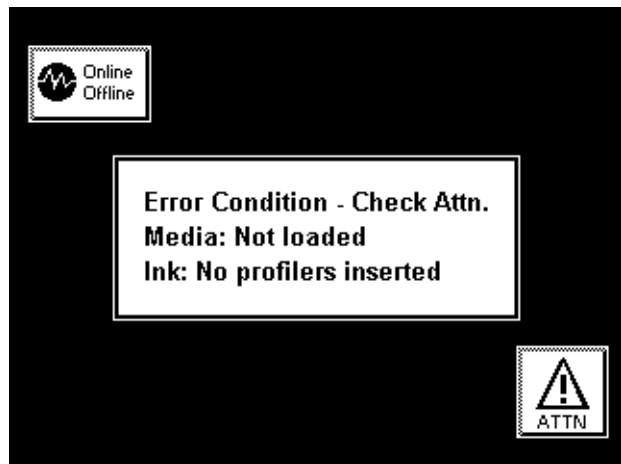

Fig. 1-9. Initial status screen after first power-up

What's Next?

- ◆ To familiarize yourself with the printer, refer to the remainder of this chapter.
- ◆ To proceed with installation, see Chapter 3, Installing Ink and Media.
- ◆ For a complete description of using the control panel, see Chapter 2, Using the Control Panel.

Workflow Overview

When the printer is connected to a ColorMark Pro print server, here is how a typical print job progresses from the client workstation to the printer. If you are using a non-ColorSpan RIP, refer to the documentation that accompanies it for details.

1. The operator sends a file to be printed from a client workstation.
2. The print job is received by the print server.
Once it reaches the print server, the print job may be reprioritized, combined with other jobs, re-routed, or otherwise manipulated. Refer to the print server online help or manual for instructions.
3. The print server RIPs the job.
The raster image processing (RIP) process translates the PostScript language data that comprises the print job into the data required by the printer.
4. The server sends the image to the printer for printing.

Parts Overview

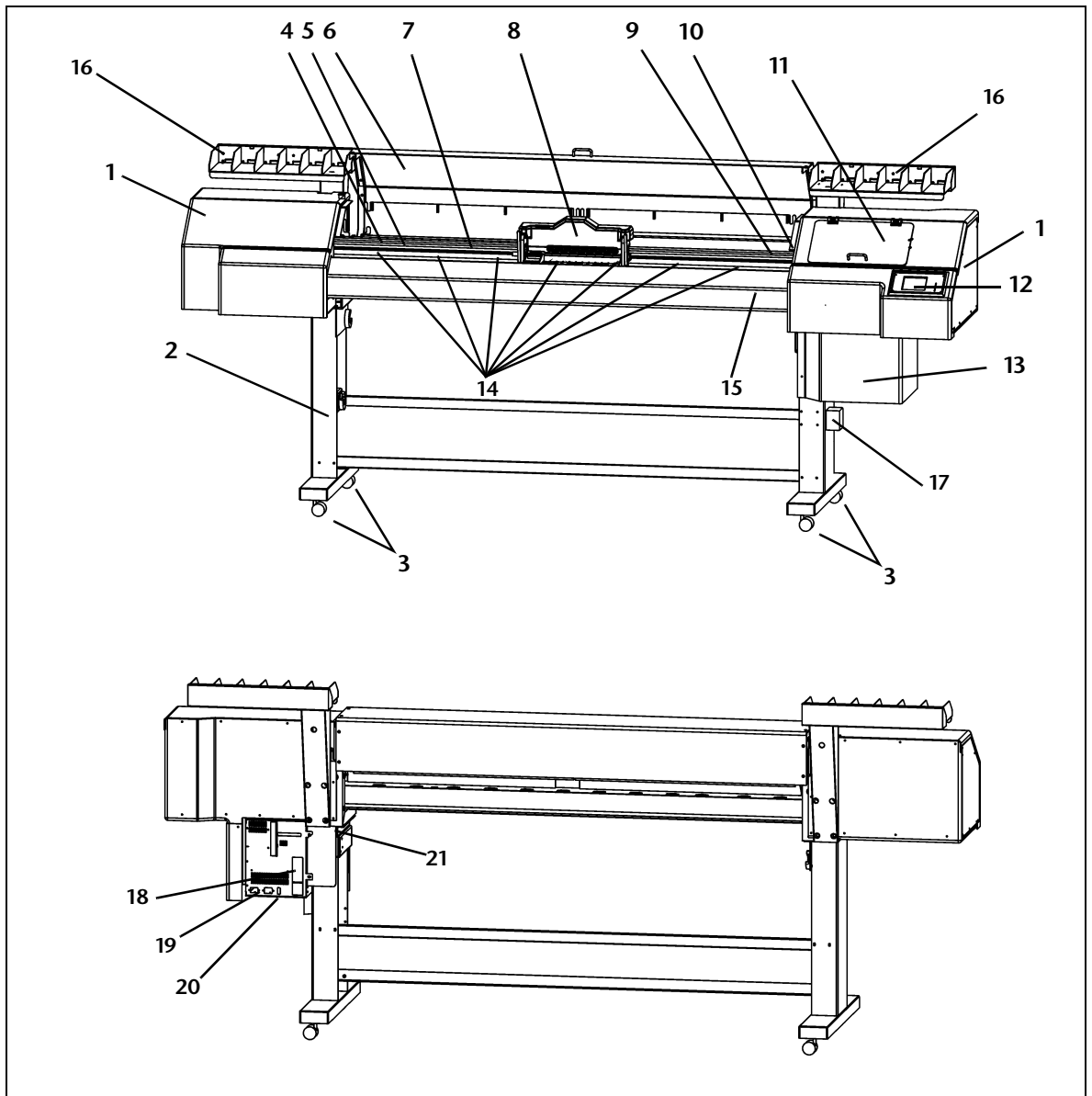
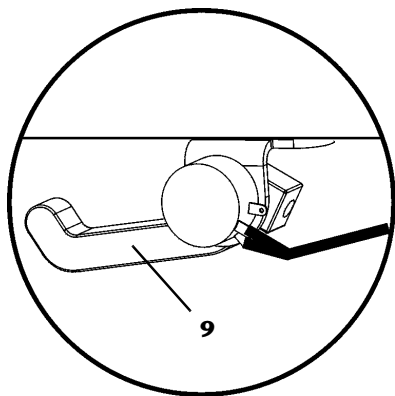

Fig. 1-1. Major parts of the printer

Index Description

- 1 **End cap (two places)** — includes removable end covers for maintenance access.
- 2 **Stand** — supports the printer.
- 3 **Casters (four places)** — enables easy location of the printer, can be locked in place.
- 4 **Encoder strip** — allows precise positioning of the print-head carriage across the length of the platen.
- 5 **Main carriage drive belt** — moves the carriage across the length of the platen.
Transport chain (not shown) — supports the ink supply tubes that carry ink from the ink reservoirs to the printheads.
- 6 **Top cover** — protects the user from the rapid motion of the printhead during printing. A safety interlock switch stops printing and cancels the print if the cover is raised.
- 7 **Platen** — supports the media under the printheads during printing.
- 8 **Printhead carriage** — carries the printheads, digital imaging sensor, and photodiode across the length of the platen. (See also detail in Fig. 1-2. and Fig. 1-3. on page 1-20.)
- 9 **Media out sensor** — detects whether media is loaded.
- 10 **Service station (behind access door)** — catches excess ink from the printheads, wipes and caps the printheads to prevent drying and clogging while not in use.
- 11 **Prime access door** — provides access to the carriage for manually priming the printheads. A safety interlock switch stops printing and cancels the print if the cover is raised.
- 12 **Control panel** — displays messages and allows control of certain printer operations. Includes a contrast adjustment lever and audio feedback.
- 13 **Electronics module** — contains the printer's power supply and control electronics. Includes a humidity sensor to enable the printer to compensate for high-humidity conditions by slowing the speed of printing.
- 14 **Pinch rollers (12 places)** — grip the media during loading and printing.



Index Description

- 15 **Dryer tube** — carries air blown from the dryer fans to the printed output.
 - 16 **Ink reservoir tray (two places)** — holds ink reservoir boxes.
 - 17 **Takeup gearbox** — powers the takeup spool to automatically take up printed output.
 - 18 **VideoNet port** — connects printer to print server.
 - 19 **Power inlets** — connects printer and the dryer's heater to electrical power.
 - 20 **Standby power switch** — places printer in standby mode (to disconnect from power, disconnect power cord).
 - 21 **Media advance switch** — enables user to manually advance media during loading.
 - 22 **Printhead carriage lock lever (two places)** — locks and unlocks the printhead assembly, for tilting it to the upright position and returning it to the printing position.
 - 23 **Printhead cover (three places)** — secures the printheads to the carriage.
 - 24 **Printhead cover latch (three places)** — locks the printhead cover in place.
 - 25 **Printhead (replaceable, up to twelve places)** — delivers ink to the media.
 - 26 **Digital image sensor** — detects the location of printed pixels for precise alignment of the printheads.
 - 27 **Photodiode** — enables the creation of color transforms without an external spectrophotometer (requires print server support), and the linearization of existing transforms.
-

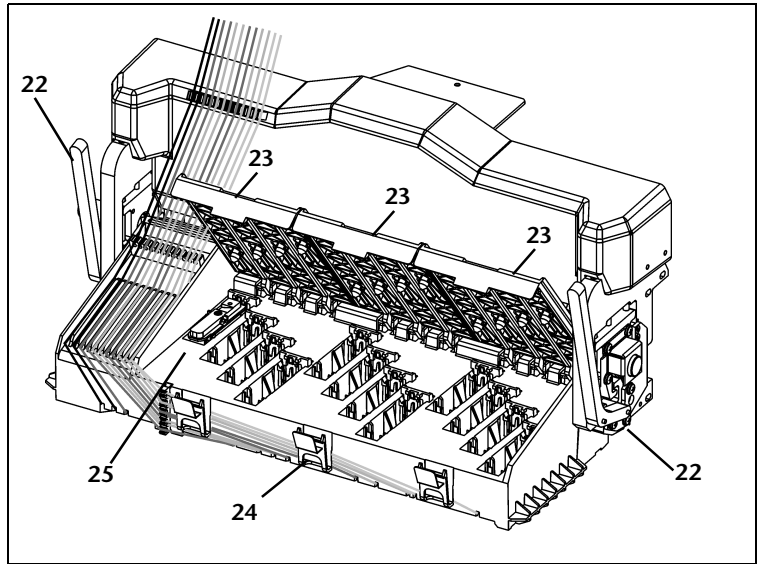

Fig. 1-2. Printhead carriage, printhead covers open

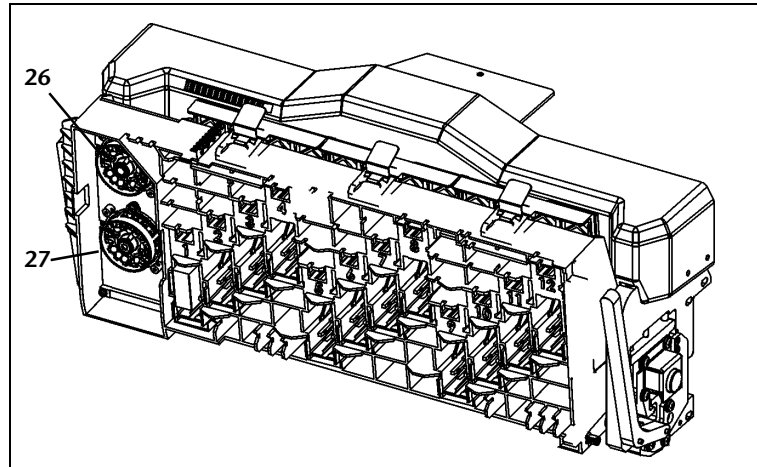

Fig. 1-3. Printhead carriage, tilted position for cleaning and accessing ink tubes

Special Features

The printer has many advanced features to help you produce the best printed output with the least effort.

Performance Features

- ◆ **AutoSet Calibration** — uses a high-resolution digital imaging sensor to automatically align printheads in the x-y directions and bidirectionally for precise positioning of ink jet pixels, also compensates for lost or misfiring jets by using substitute jets *without* slowing printing speed.
- ◆ **AutoTune** — can run AutoSet at user-defined intervals, for highest quality during unattended printing. Optionally, if print quality falls below a user-defined level, printing stops until the problem is corrected.
- ◆ **Onboard linearization** — uses the onboard photodiode to linearize output over the entire density range (with print server or RIP support).
- ◆ **Integrated heated dryer** — dries output as it prints. Optionally, the dryer fan may be turned off to avoid streaking on poly and film media.
- ◆ **Humidity sensor** — slows printing in high humidity conditions to ensure drying, and alerts the user when the ambient humidity is outside of optimal range.

Ease-Of-Use Features

- ◆ **Modular ink delivery system** — the ink system consists of three components—ink reservoir, ink tube, printhead—each of which can be replaced independently of the others as needed.
- ◆ **Tilt-up print-head carriage** — printhead carriage tilts up for easy access to the ink tubes, printheads, and image sensors.
- ◆ **Manual priming system** — recovers clogged ink jets without removing the printhead from the printer.
- ◆ **Manual air purging system** — recovers printheads that are disabled due to too much air being introduced.
- ◆ **Integrated bidirectional takeup system** — takes up printed output onto a spool for extended unattended printing. Output may be wound image-side out or image-side in.
- ◆ **Media width sensing** — automatically detects the width and position of the media loaded, for precise image placement.
- ◆ **Simplified control panel interface** — Front Page screen presents frequently-used functions, with recommended preset configurations. A menu provides access to less-frequently used functions and troubleshooting help.

- ◆ **User assistance** – control panel features online help, interactive procedures, and diagnostics to assist the user “on-the-fly,” reducing training and troubleshooting time.

CHAPTER 2

Using the Control Panel

This chapter describes the functions of the control panel.

- ◆ Overview (page 2-2)
- ◆ Front Page (page 2-5)
- ◆ Navigation Keys (page 2-9)
- ◆ Menu (page 2-10)
- ◆ Menu Tree (page 2-19)

Overview

The touch-screen control panel shows you the printer's current status, and enables you to interact with the printer when changing media and ink, respond to an error condition, or configure options. There are three main control panel screens:

- ◆ Ready (Status) Screen
- ◆ Front Page
- ◆ Menu

Ready Screen

When you press the Online/Offline button from the Front Page screen, the printer goes online and the Ready or Status screen appears. The Ready screen displays the current status of the printer and any currently printing job. It displays when the printer is online (communicating with the print server) and either ready to print or printing.

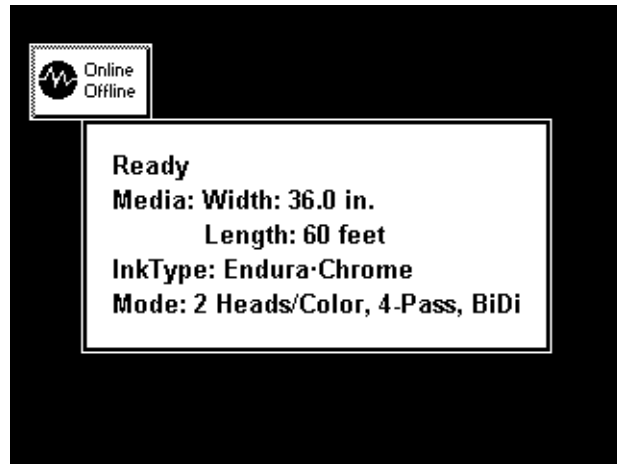

Fig. 2-1 Ready screen

Front Page

When you press the Online/Offline button from the Ready Screen, the printer goes offline and the Front Page screen appears. This screen is the top level of the printer's menu system. It provides access to the most frequently-used offline functions. For details, see "Front Page" on page 2-5.

Menu

When you press the Menu key on the Front Page screen, the Menu appears. The Menu provides access to advanced configuration options. For details, see "Menu" on page 2-10.

User Assistance

The control panel provides various forms of online user assistance:

The **? button** provides an explanation of the current function, with some guidance for what to do next.

The **ATTN (Attention) key** blinks on the control panel when the printer detects an error condition, potential error condition, or when you make a change that suggests recalibration or other action to ensure best print quality. There are three types of ATTN messages:

- ◆ **Actions** — the printer has detected an error condition that stopped printing or will prevent printing from starting. You must correct the error before the printer will be ready to print. When the printer senses that the error condition has been addressed, the Action will be deleted the next time the ATTN key is pressed.
- ◆ **Warnings** — the printer has detected a condition that, if left unaddressed, could result in substandard prints or a condition that will require an action before printing can continue. Any action on your part is optional, printing is not interrupted for a Warning message.
- ◆ **Changes** — the printer has detected a change to the inks, media, or printer that could affect print quality. Pressing the ATTN key displays a message that suggests the actions to perform for optimal print quality, such as recalibration. You can dismiss the message with or without actually performing the suggested action, although ignoring the messages could result in substandard output quality. Printing is not interrupted for a Change message.

When the printer issues one of these messages, the ATTN key will blink, and an alert beep will sound. Press the ATTN key to display a list of message titles, and select a title to display a detailed cause-and-recovery screen.

If you choose to not correct a Warning or Change condition and resume printing, the ATTN key will remain displayed, but will not blink until the printer issues a new Warning, Action, or Change message. The messages can be dismissed by correcting the condition, or by pressing the applicable key on the detail screen.



Tip

See page 2-12 for instructions for choosing an Expert or Novice mode for displaying these messages (Expert mode routes most messages to the Actions & Warnings menu), and for disabling or enabling the audible alarm.

Front Page

The Front Page provides access to the most frequently-used printing and maintenance functions. For advanced configuration options, press the Menu key (see “Menu” on page 2-10 for instructions).

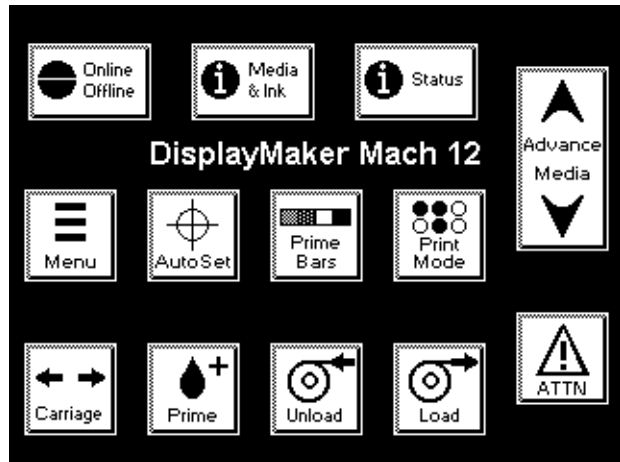

Fig. 2-2. Front Page

- ◆ **Printer Name** — displays the name of the printer as defined on the print server.
- ◆ **Online/Offline** — returns the printer to the Ready screen.

- ◆ **Media & Ink** — displays a listing of the media and ink currently installed in the printer. Press the ▼ and ▲ keys to highlight “Media” or one of the inks, then press ► (Proceed) to display information about the selection. From this screen, you can press the ◀ and ▶ keys to scroll between screens. Press ► (Proceed) to return to the list, then ⏪ (Menu Out) to display the Front Page screen.

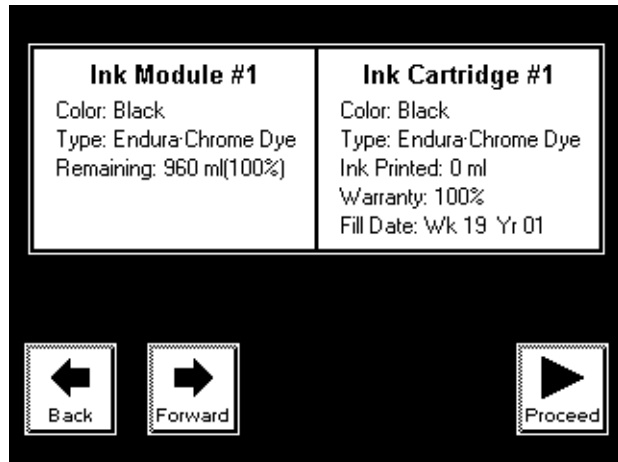
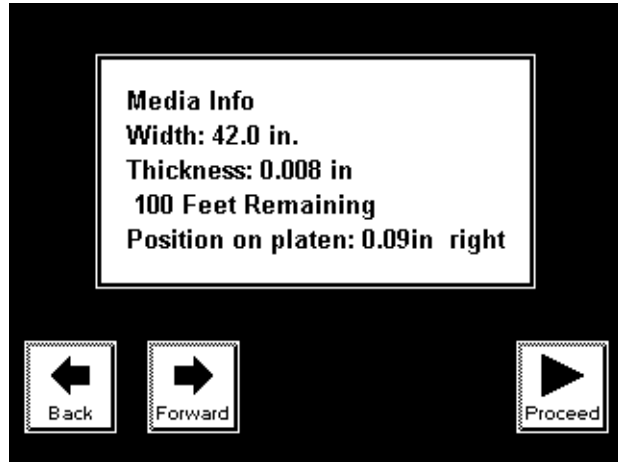



Fig. 2-3. Media info, ink info screens

- ◆ **Status** — displays the status of all user-configurable options. Press  (Page) to scroll between pages. To change an option, go to the Printer Configuration section of the menu.

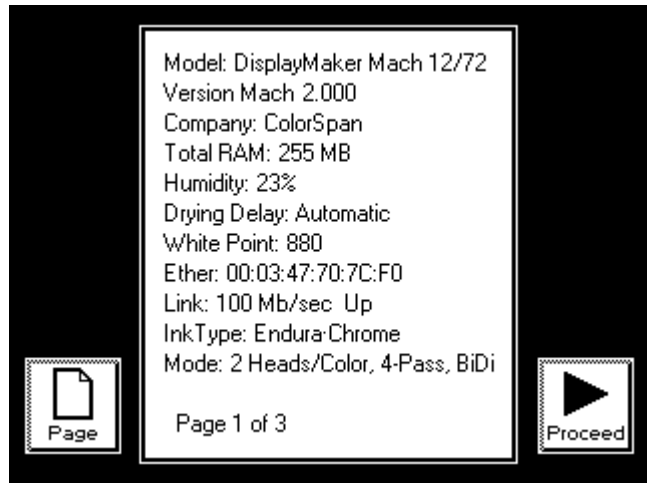







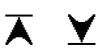











Fig. 2-4. Status page 1

- ◆ **Advance Media** — press the  key to advance the media forward. When you press and hold the  key, the media moves faster. You can also press the Media Advance switch on the rear of the printer, below the left profiler docking station, to advance the media. Press the  key to advance the media back onto the supply spool. When you press and hold the  key, the media moves faster.
- ◆ **Menu** — displays the complete printer menu for access to advanced configuration options (see “Menu” on page 2-10 for instructions).
- ◆ **AutoSet** — performs a “one touch” calibration of the printer: bidirectional and head-to-head alignment of printheads, and AutoJet substitution mapping of deflected or missing jets. See “AutoSet” on page 4-2 for instructions.
- ◆ **Prime Bars** — fires all jets by drawing a set of lines called prime bars. This is a good way to inspect and prepare the jets for printing after they have been idle for more than a few hours. Choose **Quick Prime Bars** for most primes, or **Detailed Prime Bars** when you want to locate individual missing jets that AutoSet may have missed, so you can map them manually under **Calibrate Printer - Manual Calibrations - Manual Jet Mapping** (see “Manual Jet Mapping” on page 4-13 for instructions).

- ◆ **Print Mode** — interactively assists you in installing print-heads in the correct positions, and setting the number of print passes. See “Selecting a Print Mode” on page 3-7 for instructions.
- ◆ **Carriage** — moves the carriage out of the service station so you can load or clean the printheads and ink tubes, clean the image sensors, and remove the service station.
- ◆ **Prime** — moves the printhead carriage to the priming position, so that one or more printheads can be manually primed (see “Manual Priming” on page 5-8 for instructions).
- ◆ **Media Unload** — when unloading media, prints the calculated amount of media remaining on the roll for reference (on the lower right edge). If using the takeup, cut the media from the takeup spool before pressing the Media Unload key (see “Cutting and Unloading Media” on page 3-32). When removing the partial roll from storage and re-loading on the printer, the user can report this value to the printer during the Media Load operation.
- ◆ **Media Load** — causes the printer to measure width of the media installed in the printer, checks for proper media positioning on the platen (for good vacuum contact), asks the user to enter the amount remaining on the supply roll, asks the user to select a takeup option. See “Loading Media” on page 3-24 for instructions.
- ◆ **ATTN (Attention)** — blinks on the control panel when the printer detects an error condition, potential error condition, or when you make a change that requires recalibration or other action to ensure best print quality. See “User Assistance” on page 2-3 for further details.

Navigation Keys

The following table shows you how to move through the menu system and perform printer control functions.

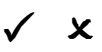
Key	Description
	Display Menu – displays the printer menu.
	Menu Up/Down – moves the menu highlight up and down the menu.
	Menu Top/Bottom – moves the menu highlight to the top or bottom for the menu.
	Menu Out, Menu In – moves to the next higher menu in the hierarchy, or selects the highlighted option.
	Back/Forward – moves between pages or screens, or selects printheads to calibrate.
	Proceed – initiates the selected function.
	Page – switches between pages of a multi-page screen.
	Help – displays a summary description of the highlighted menu options.
	Pause/Resume – pauses or resumes printing during a calibration.
	Cancel – cancels the current menu function or choice.
	Continue (error screen) – proceeds to the next step in a troubleshooting dialog.
	Ignore (error screen) – specifies “ignore” in a troubleshooting dialog.
	Retry (error screen) – specifies “retry” in a troubleshooting dialog.
	Reboot Printer (error screen) – specifies “restart printer” in a troubleshooting dialog.
	Information (error screen) – displays further information about the error.
	Yes/No (error screen) – indicates a Yes or No in a troubleshooting dialog.

Menu

The menu has three main sections:

- ◆ Calibrate Printer (see below)
- ◆ Printer Configuration (page 2-11)
- ◆ Service Printer (page 2-16)
- ◆ Warnings & Actions (page 2-18), shown in Expert Messages Mode only

This section explains each of the functions on the printer menu.

Calibrate Printer

For details on these options, see Chapter 4, Calibrating the Printer.

- ◆ **Manual Calibrations** — allow you to calibrate the media feed advance accuracy, and perform the various components of the automatic AutoSet calibration visually, without the printer's digital imaging sensor. Inaccurate judgments by the operator during these tests could result in substandard output. In most cases, use AutoSet instead. See "Manual Calibrations" on page 4-3 for instructions.
- ◆ **Auto Calibrations** — enables you to run a portion of the AutoSet calibration, to save time. See "Auto Calibrations" on page 4-19 for instructions.
- ◆ **AutoTune** — schedules AutoSet to run automatically after a certain number of prints have printed. See "AutoTune" on page 4-20 for instructions.
- ◆ **Calibration Summary** — prints summary information with the AutoSet calibration test patterns, or transmits registration or jet data to a log file on the print server. "Calibration Summary" on page 4-21 for details.

Printer Configuration

Printer Configuration enables you to set many options that control how the printer operates.

Print Settings

- ◆ **Top Gutters** — allows you to turn on or off the gutter pattern at the top edge of the print, which shows data about the print such as date and time printed and print mode, plus write-in blanks for other data.

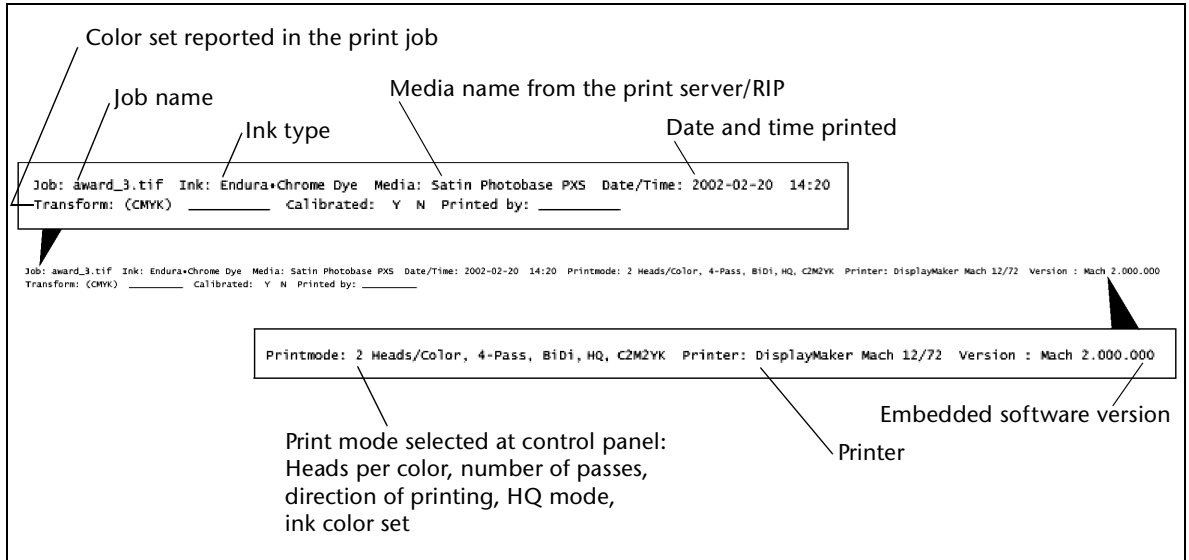

Fig. 2-5. Top gutter data

- ◆ **Side Gutters** — sets the side gutter pattern to narrow, medium, or wide sizes, or disables them. Side gutter patterns help keep the ink jets open by firing ink through them in a pattern outside the printed image area.
- ◆ **Takeup Direction** — sets the direction of the takeup motor for Image Inside or Image Outside takeup.
- ◆ **Takeup Control** — enables and disables the takeup system.
- ◆ **Platen Vacuum Control** — turns on the vacuum fans, then allows you to raise or lower the speed of the vacuum fans. Raise the speed if the media is rising off the platen, lower the speed if the media is buckling or wrinkling.

- ◆ **Head Height** — sets the height of the printhead to Normal (0.050 inches/1.27 mm) or Custom. Use Normal unless the media is curling or the printhead carriage is striking the media. Lower settings reduce ink overspray, but increase the chances of the printhead striking the media. When the head height is 0.070 inches (1.78 mm) or higher, do not run AutoSet, run the manual calibrations instead.
- ◆ **Space Between Prints** — sets the blank space between print jobs, between 0 and 10 inches (25 cm).
- ◆ **Right and Left Margin** — sets the amount of blank space for the right and left margins, between 0 and 5 inches (13 cm).
- ◆ **Service Station** — sets the printhead service station cycle: every 30 seconds, spit-and-wipe (default); or every 30 seconds with spit only. The service station cycle helps keep the ink jets open when not printing by expelling ink and (optionally) wiping the jets.

- ◆ **Drying Delay** — select the printer's preprogrammed algorithm for slowing the print speed when the ambient relative humidity is excessive, or specify a custom drying delay in seconds per print swath. A longer delay allows the output to remain under the dryer longer, which ensures adequate drying under higher ambient relative humidity.

Printing automatically occurs at a speed that ensures that the output will be dry before it reaches the takeup spool, depending on the level of ambient relative humidity.

To increase the media advance speed, you can specify a manual drying delay. If you specify a manual drying delay interval that will be insufficient to dry the output, the printer will display a warning message on the control panel. Be aware that if you override this warning without increasing the drying delay, you should not use the takeup system, and take care to remove output from the printer before it reaches the floor, and store it flat until it dries. Using the takeup to collect wet output, or allowing wet output to pile on the floor, would likely result in ruined prints.

- ◆ **Units** — sets English or metric units of measure for data displayed by the control panel.
- ◆ **Expert/Novice Messages** — **Novice** mode presents Warnings & Changes (alerts that do not prohibit printing) and Actions (conditions that require user intervention before printing can proceed). **Expert** mode presents Actions only, presents fewer "press Proceed" prompts after an Action has been addressed, and does not require you to press Proceed

after manually winding back a service loop. The default is Novice mode.

When in Expert mode, active Warnings, Changes, and Actions can be displayed by selecting **Warnings & Actions** from the menu, since Warnings will not cause the ATTN icon will appear in Expert mode. See “User Assistance” on page 2-3 for further information about Actions and Warnings. See “Warnings & Actions” on page 2-21 for further information about this menu option.

- ◆ **Audible Alarm** – when enabled and one or more Actions are pending, sounds a beep until the ATTN key is pressed.
- ◆ **Service Station Spits** – adjusts the number of times ink is expelled (“spit”) during a single service station visit. The settings are 1 through 10. To reduce the number of missing or misfiring jets, increase this setting.
- ◆ **SS Overspray Delay** – when enabled, this setting will pause the printhead carriage in the service station area briefly (approximately one second) before exiting, to eliminate fine overspray on the right side of prints (nearest the service station).

Printer Options

- ◆ **Dryer** – turns the dryer fans on or off. Disable the dryer fan to avoid streaking output on poly media and films.
- ◆ **Print White Space** – when enabled (on), the printhead carriage always travels the width of the media, even when there is a white (blank) space in the image. When disabled (off), the printhead remains in its home position and the media advances past white spaces in the image.
- ◆ **Quality Check** – when enabled, the printer determines the number of misfiring or not firing ink jets that are not being replaced by other jets. If this number exceeds a maximum value, an error occurs. This can give the operator a chance to print anyway, or cancel printing so the problem can be resolved.
 - ◆ **Attended Mode** – user must press ► (Proceed) to acknowledge the error and print the job (if one is pending), or ✕ (Cancel) to cancel printing.
 - ◆ **Unattended Mode** – no user acknowledgment of errors is required. When a quality check fails, print jobs are sent to the ColorSpan print server’s Attention queue with a disposition of “Uncalibrated Printer” (this feature may not be supported on non-ColorSpan print servers).

- ◆ **OFF** — no quality check is performed, all jobs will print.
- ◆ **Print Position** — positions the print in the horizontal (x-axis) direction, either in the center or flush right.
- ◆ **Media Supply Loop** — the supply loop is the slack portion of the media between the platen and supply spool. When the media is backed up to reduce the amount of blank (unprinted) space between print jobs, the result is a supply loop. A supply loop can cause printing anomalies if not removed. The printer provides three options to handle the supply loop:
 - ◆ **Prevent Supply Loop** — use this mode to ensure optimal quality and speed (see Tip below). The media is not backed up and no supply loop is created. Prints will move completely through the dryer before the next print begins.
 - ◆ **Allow Supply Loop** — use this mode for optimal printing speed or to manually remove the supply loop after each print. Prints will move completely through the dryer, then the media is backed up, and the user is prompted to remove the supply loop by manually rewinding the slack portion onto the supply spool. Printing resumes after the user presses the Proceed key, or after 60 seconds, whichever occurs first.
 - ◆ **Unattended Supply Loop** — use this mode to remove the supply loop as in Allow Supply Loop mode, or the printer will do it and printing proceeds as in Prevent Supply Loop mode. Printing proceeds as in Allow Supply Loop, but if the user does not press Proceed after 60 seconds, the media is advanced to its location after drying and printing proceeds.



Tip

Use the ColorSpan print server's MediaSaver or N-Up features to group separate print jobs into a single job. This conserves media and speeds printing by eliminating the blank space between jobs, without creating a supply loop.

Reset All Defaults

- ◆ **Restore All Defaults** — restores all Printer Configuration settings to their factory default values, and zeroes all registration data. After running this option, all calibration values must be reestablished by running AutoSet.
- ◆ **Zero Platen Width** — sets the platen width to zero, which forces the printer to measure the platen on the next power up.
- ◆ **Measure Platen** — measures the platen width.

Service Printer User Diagnostics

User Diagnostics presents an interactive troubleshooting program to diagnose problems before calling MacDermid ColorSpan Technical Services. It walks you through a series of tests and checks for certain printer functions. The printer asks you to make observations or run simple tests to help it diagnose problems and suggest corrective actions. It has the following sections:

- ◆ **VideoNet Status**
- ◆ **Head Statistics**
- ◆ **Carriage Motion**
- ◆ **VideoNet Connection**
- ◆ **Calibration**
- ◆ **Error History**
- ◆ **Actions and Warnings List** — table of all actions and warnings with cause and recovery. This is an abbreviated version of the table on page B-5.
- ◆ **Log Error History**

Service Tests

These tests are for factory, service, and technical support use.

- ◆ **Control Panel Test** — tests the functionality of the control panel display.
- ◆ **Spit and Wipe Jets Test** — tests the functionality of the service station by firing ink (spit) and drawing the printheads over the service station wipers (wipe).
- ◆ **Takeup Test** — tests the functionality of the takeup system.
- ◆ **Print Test** — the user selects one of the twelve printheads to test, then the printer begins firing that printhead continuously until canceled by the user. The test can help to identify an intermittently failing printhead.
- ◆ **Profiler Test** — identifies and verifies profilers in each position. The printer will report the profiler number, color, and ink percentage remaining. Particularly useful when the printer is connected to a non-ColorSpan RIP that cannot display profiler status.
- ◆ **Vacuum Fan Test** — runs the platen vacuum fans to test for correct operation.

- ◆ **Dryer Test** — runs the dryer heater assembly to test for correct operation.
- ◆ **Print Image on Image Sensor** — the printer prints a small set of lines which are scanned by the digital image sensor. Then the printer prints an enlargement of the image as the sensor captured it.
- ◆ **Horizontal Dot Accuracy** — for factory/service use only.
- ◆ **Vertical Dot Accuracy** — for factory/service use only.
- ◆ **Isolation Print Test** — for factory/service use only.
- ◆ **Pod Test** — for factory/service use only.

Calibrations

These calibrations are performed at the factory. If any of them are detected as out-of-specification, a message is displayed on the control panel, recommending that you perform the applicable calibration:

- ◆ **Head Height** — re-homes the head height to the known highest reference point, or if New Carriage was previously selected (see below), recalibrates the known highest reference point
- ◆ **Media Sensor** — locates the platen to establish the “media out” head height
- ◆ **White Point** — reads the white point reference chip in the platen to establish a white point for the photo diode.

Home Head

Recalibrates the home position of the printhead carriage. If the printhead carriage will not return to the service station between prints, select this option. Cycling the power off and on will also run the Home Head function.

Measure Media Width

Measures the width of the media.

New Carriage

Reinitializes the head height so that it can be recalibrated (see “Calibrations,” above).

Prime Bars

Prints a wide-swath version of the prime bars.

Disable Media Sensor

If the media sensor is malfunctioning, disable it to continue printing. Note that with the media sensor disabled, the printer will not be able to detect when there is no media in the printer.

Warnings & Actions

When in Expert mode, active Warnings, Changes, and Actions can be displayed by selecting Warnings & Actions from the menu, since Warnings will not cause the ATTN icon will appear in Expert mode. This option does not appear in Novice mode.

See “User Assistance” on page 2-3 for further information about Actions and Warnings. See page 2-12 for a description of the Expert/Novice Messages mode.

Menu Tree

Front Page

- Online/Offline
- Media & Ink
- Status
- Advance Media
- Menu
- AutoSet
- Prime Bars
- Print Mode
- Carriage
- Prime
- Media Unload
- Media Load

Calibrate Printer

Manual Calibrations

- Media Feed
- Manual Bidi Registration
- Manual Head Registration
- Manual Jet Mapping
- Jet Status Lines
- Default Registration Data

Auto Calibrations

- AutoBidi Calibration
- AutoH2H Calibration
- Auto Bidi & H2H Calibration
- AutoJet Calibration

AutoTune

Calibration Summary

- AutoSet Summary
- Log Head Registration Data
- Log Jet Data

Configure Printer

Printer Settings

- Top Gutters
- Side Gutters
- Takeup Direction
- Takeup Control
- Platen Vacuum Control
- Head Height
- Space Between Prints
- Right and Left Margin
- Service Station
- Drying Delay
- Units
- Expert/Novice Messages
- Audible Alarm
- Select Pen Temperature
- Service Station Spits
- SS Overspray Delay

Printer Options

- Dryer
- Print White Space
- Quality Check
- Print Position
- Media Supply Loop

Reset All Defaults

- Restore All Defaults
- Zero Platen Width
- Measure Platen

Service Printer

User Diagnostics

- VideoNet Status
- Head Statistics
- Carriage Motion
- VideoNet Connection
- Calibration
- Error History
- Warnings and Actions List

Log Error History

Service Tests

Control Panel Test

Spit and Wipe Jets

Takeup Test

Print Test

Profiler Test

Vacuum Fan Test

Dryer Test

Print Image on Image Sensor

Horizontal Dot Accuracy

Vertical Dot Accuracy

Isolation Print Test

Pod Test

Calibrations

Head Height

Media Sensor

White Point

Home Head

Measure Media Width

New Carriage

Prime Bars

Disable Media Sensor

Warnings & Actions (Shown in Expert mode only)

CHAPTER 3

Installing Ink and Media

This chapter describes:

- ◆ Variable Mode Printing (page 3-2)
- ◆ Ink System Overview (page 3-4)
- ◆ Selecting a Print Mode (page 3-7)
- ◆ Installing Ink for the First Time in a New Printer (page 3-12)
- ◆ Replacing Ink System Components (page 3-17)
- ◆ Loading Media (page 3-24)
- ◆ Cutting and Unloading Media (page 3-32)

Variable Mode Printing

The printer uses these techniques to vary the quality of a print and speed of printing:

- ◆ **Direction** — for fastest print speed, the printheads fire ink bidirectionally, when the carriage travels in both directions. To reduce certain banding effects, the printheads can be set to fire only when the carriage is moving to the left.
- ◆ **High quality (HQ)** — when enabled, reduces certain banding effects.
- ◆ **Color Set** — ink sets may contain one each of a different color, two each of a different color, varying densities of certain colors, or combinations. Using two sets of colors speeds printing, while using multidensity inks creates smoother transitions between light tones, and increases the perceived resolution of the print.
- ◆ **Jet Replacement** — jets on the printhead that are misfiring or not firing at all can be replaced with alternate jets. Ideally, every pixel called for in a print is printed. In reality, some pixels are not printed because the ink jets tend to become partially or completely clogged with ink, which reduces print quality. AutoJet mapping substitutes an otherwise unused jet for a missing or deflected jet.
- ◆ **Passes** — number of times the printhead passes over a given area of the image. A greater number of passes makes a greater number of substitute jets available, but slows printing speed.

Print quality (apparent resolution and smooth gradients) is improved by:

- ◆ Increasing the number of passes (see “Selecting a Print Mode” on page 3-7)
- ◆ Increasing the number of different ink colors (and/or densities); see “Selecting a Print Mode” on page 3-7
- ◆ Printing in HQ mode (see “Selecting a Print Mode” on page 3-7)
- ◆ Printing unidirectionally (left only); see “Selecting a Print Mode” on page 3-7
- ◆ Selecting “Do not print white space” under **Configure Printer - Printer Options - Print White Space** (see “Printer Options” on page 2-13)
- ◆ Using MediaSaver (ColorSpan Print Server feature) to group jobs together, eliminating the drying delay between jobs

Print speed is increased by:

- ◆ Reducing the number of passes (see “Selecting a Print Mode” on page 3-7)
- ◆ Reducing the number of different colors or using smaller ink sets (four or six colors instead of eight or more)
- ◆ Printing with two heads per color (see “Selecting a Print Mode” on page 3-7)
- ◆ Printing bidirectionally (in both directions); see “Selecting a Print Mode” on page 3-7
- ◆ Printing in non-HQ mode (see “Selecting a Print Mode” on page 3-7)
- ◆ Printing in low relative humidity to avoid drying delays
- ◆ Disabling the service station overspray delay under **Configure Printer - Printer Settings - SS Overspray Delay** (see page 2-13)

Ink System Overview

The printer's ink system consists of three main components:

- ◆ **Ink reservoir** — a plastic box containing the ink supply and an electronic profiler, which specifies the ink type, color, and amount remaining. The profiler plugs into a connector on the ink tray, allowing it to communicate with the printer and print server. The reservoir is self-contained and seals automatically for easy handling.
- ◆ **Ink tube** — carries the ink from the reservoir to the print-head, self-sealing on both ends for ease of handling.
- ◆ **Printhead** — delivers the ink to the media.

Each of these components can be replaced independently of the others. This enables you to consume the ink from two or more reservoirs before replacing the printhead when an excessive number of clogged jets cannot be recovered with priming or cleaning. The ink tubes need not be replaced unless you switch ink types (for example, from a dye ink to a pigmented ink, or to a different set of colors), or if a tube becomes damaged.

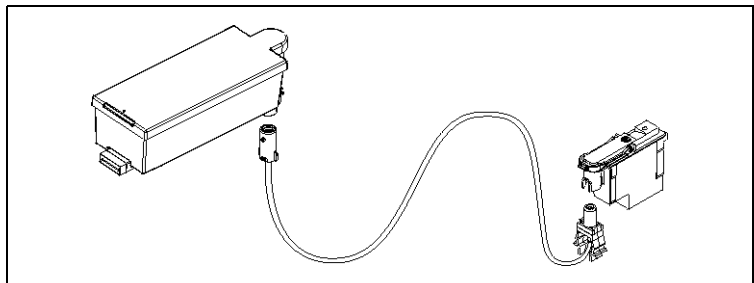

Fig. 3-1. Ink system components

The ink system also includes a labeling system to help keep the components of each ink color together:

- ◆ **Color Map Cards** – lists all of the supported ink sets, fits in plastic sleeve inside the printer's top cover for easy reference during installation and printing.

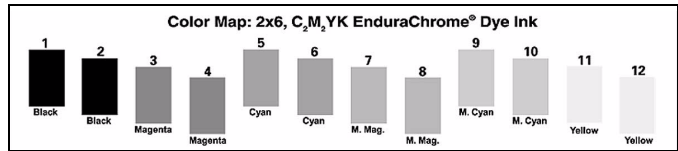

Fig. 3-2. Color Map card

- ◆ **Ink Type Label** – used to identify the ink type used in each ink tube.
- ◆ **Ink Tube Number Label** – used to label each end of each ink tube (ink reservoir end and printhead end) from 1 to 12; corresponds to the factory-labeled ink tray positions 1 to 12.

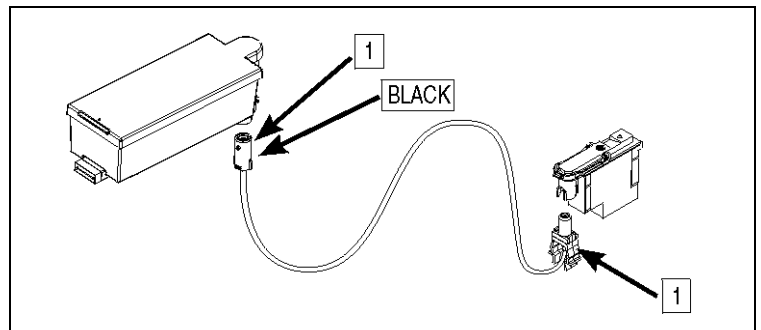

Fig. 3-3. Ink type and ink number labels

Spare Ink and Printheads

For maximum productivity and minimum down time, ColorSpan recommends stocking extra ink reservoirs and printheads. When the ink supply runs low, or a printhead needs to be replaced, having spares will ensure that printing can resume as quickly as possible.

Since ink and printhead usage will vary depending on the amount and types of printing you do, experience will help you determine how to stock an efficient spare inventory. For example, in a “2x6” configuration (two six-color sets of ink), ColorSpan recommends stocking two six-color sets of ink reservoirs, plus six printheads (one for each color). Both ink reservoirs in a pair tend to run out of ink at the same time, so two spares per color would allow you to continue printing with a minimum of delay. The printheads tend to need replacement one at a time, so one spare per color would be sufficient most of the time.



Tip To clean a printhead with jet-outs, see “Cleaning Ink Jets” on page 5-3.

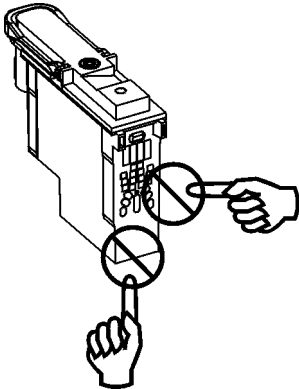

Printhead Handling Tips

- ◆ **DO** hold the printhead by the plastic body only.
- ◆ **DO** clean the printheads with a clean lint-free cloth moistened with plain water.
- ◆ **DO NOT** touch the ink jet nozzles on the bottom of the printhead.
- ◆ **DO NOT** touch the electrodes on the back of the printhead. The printhead is fired by an electrical signal. The electrodes that carry this signal are easily contaminated.
- ◆ **DO NOT** set the printhead down anywhere before you install it.
- ◆ **DO NOT** wipe the printhead with any fiber-cellulose material, such as a paper tissue.
- ◆ **NEVER APPLY ISOPROPYL ALCOHOL ON THE PRINTHEAD OR SERVICE STATION. USE PLAIN WATER.** Alcohol reacts with pigmented inks, rendering the printhead unusable. To clean ink clogs, see “Cleaning Ink Jets” on page 5-3.

Selecting a Print Mode

Before installing ink, report to the printer how you will use the ink you will install (the “print mode”). This is necessary because although the printer can detect which inks are installed, a given ink set may be usable in several different modes.

For example, consider an installation of two six-color (C2M2YK) sets of ink. By changing the color map selected at the control panel, and without moving or removing any of the ink reservoirs or printheads, these twelve inks may be used as:

- ◆ 2 six-color ink sets
- ◆ 1 six-color ink set
- ◆ 2 four-color ink sets
- ◆ 1 four-color ink set

See “Switching Between Ink Sets” on page 3-10 for further details.

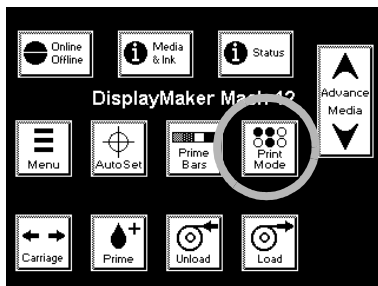

To configure the print mode:

1. From the Front Page screen on the control panel, press the Print Mode key.

The control panel displays the Current Selection screen. This shows the current settings for the options you are about to specify.

2. Press the ► (Proceed) key.

The control panel displays the Print Direction menu.

3. Press the ▲ and ▼ keys to select the BiDi or Left Only print direction, then press the ✓ key.

The control panel displays the Select Heads Per Color menu. For both options, you can also specify a High Quality (HQ) mode.

4. Press the ▲ and ▼ keys to select the number of printheads per color you plan to use, then press the ✓ key.

The Select Ink Type menu appears.

5. Press the ▲ and ▼ keys to select the ink type, then press the ✓ key.

The control panel displays the Select Color Map screen. At the top of this screen are the color sets that are valid for the number of heads per color you selected. At the bottom of the screen is a schematic diagram showing the placement of the printheads in the printhead carriage.

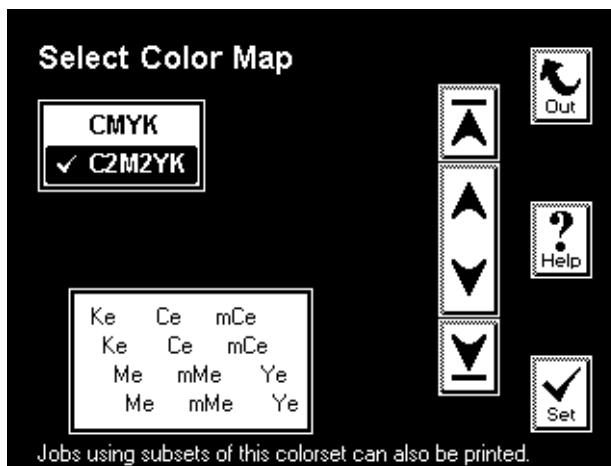

Fig. 3-4. Select Color Map screen

Printhead Positions

1	5	9
2	6	10
3	7	11
4	8	12

Ink Colors

C	Cyan
mC	Medium Cyan
IC	Light Cyan
M	Magenta
mM	Medium Magenta
IM	Light Magenta
Y	Yellow
K	Black
xxx	Ignored/Not used

Ink Type (Suffix)

e	Endura • Chrome
p	Perma • Chrome

6. Press the ▲ and ▼ keys to select the color map you will use.
The color map diagram changes with your selection.
7. Press ✓ to continue.
The control panel displays the Select Passes menu.
8. Press the ▲ and ▼ keys to select the number of print passes you want to use.
A higher number of passes produces the best print quality, but a lower number of passes will increase print speed. The default is 8 passes.
9. Press ✓ to continue.
The Front Page screen appears. The print mode is now selected. If you changed the number of passes by more than one pass, you should run a Media Feed Calibration (see “Media Feed Calibration” on page 4-4) and Head-to-Head registration (“Auto Calibrations” on page 4-19) before printing.
10. Install the Color Map card that corresponds to the mode you selected into the plastic sleeve on the printer’s top cover.
Refer to the Color Map card to help you load inks into the correct locations. See the figure on page 3-5 for an illustration of a Color Map card.

Switching Between Ink Sets

The inks are located in specific numbered locations on the printer for optimal print and color quality. The software ignores ink positions that are not needed for a print mode, so any ink (or no ink) can be present in these positions. This provides flexibility while minimizing the need to swap or reposition inks. For example, by loading a 2x6 C2M2YK ink set, you can switch between 2x6, 1x6, 2x4, and 1x4 print modes at the control panel without moving or changing any inks (see below).

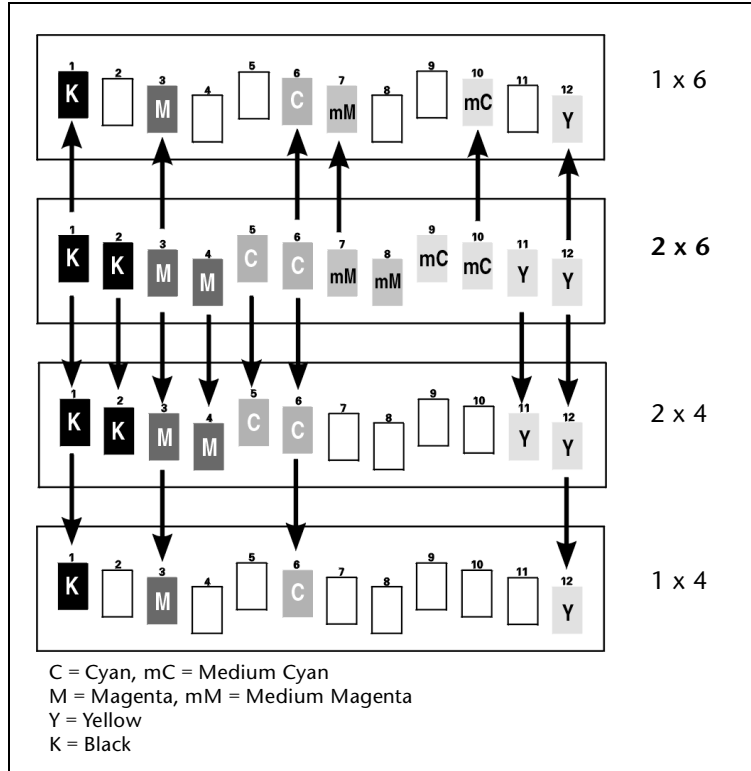

Fig. 3-5. Possible modes with a 2x6 ink set

Switching between eight-color and six-color modes, however, does require switching ink(s):

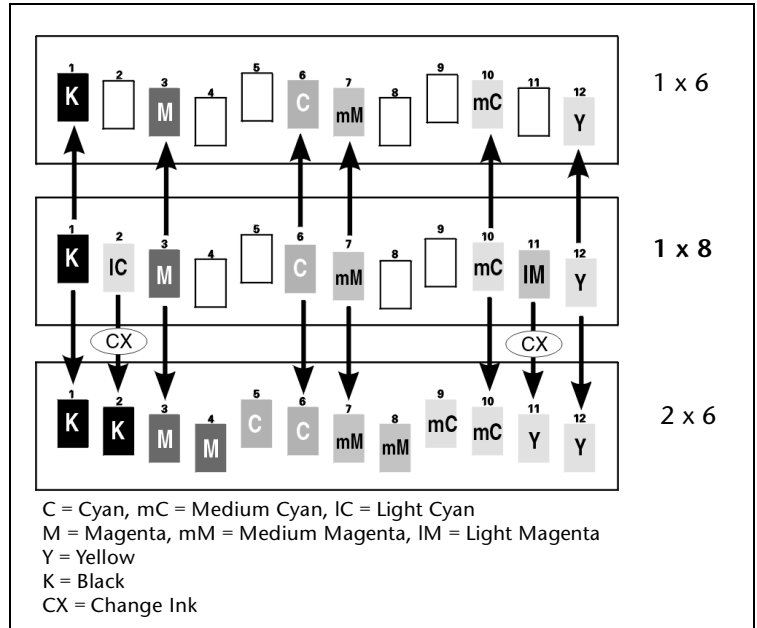

Fig. 3-6. Possible modes with a 1x8 ink set



Caution

When changing ink colors, if you change the printhead and reservoir without changing the existing ink tube, ink from the reservoir will mix with the different ink in the ink tube, producing a third color. When you change ink colors, you must replace the existing printhead, tube, and reservoir with the printhead, tube, and reservoir containing the new ink color.

The printer will display an error if you install a printhead and/or reservoir in the wrong position for the selected ink set, but it cannot detect whether the ink tube does not match the other components.

Since inks of different dilutions are very difficult to visually discern in the ink tubes, be sure to label all components and replace them one color at a time, as described in "Replacing Ink System Components" on page 3-17.

Installing Ink for the First Time in a New Printer

When you receive a new printer, numbered empty ink tubes are preinstalled at the factory. This prepares the printer to accept ink reservoirs and printheads with any ink type or color set. It also avoids introducing air into the ink, which would occur gradually if ink tubes filled with ink were installed and stored unpressurized (without an ink reservoir connected).

During the ink installation process, you will displace the air inside the ink tube with ink before you connect the tube to the printhead.



Caution Always fill an empty ink tube with ink before connecting it to a printhead. Connecting an empty ink tube to a printhead will result in enough air to be introduced to cause the printhead to fail. This condition may be recoverable by purging the cartridge of air (see “Purging the Printheads” on page 5-11 for instructions), and then priming them (see “Manual Priming” on page 5-8).

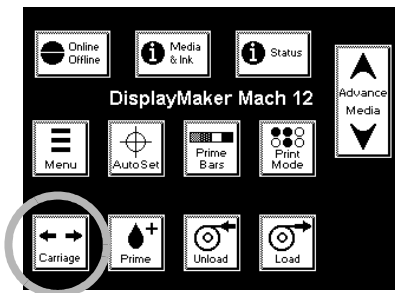

1. On the printer’s Ready screen, press the Online/Offline key. The Front Page screen appears.

2. On the control panel Front Page screen, press the Carriage key.

The printhead carriage moves to the center area of the platen so you can load the printheads.

3. Open the printer’s top cover.

4. If desired, label the ink tubes at the reservoir end.

Referring to the Color Map card, affix the labels showing the ink color and ink type onto the ink tubes at the reservoir end. This will identify the ink used in each tube, and help reconnect any tubes that are removed and stored to the correct ink reservoir and printhead.

5. If not pre-assembled, insert the drain tube into the connection on top of the drain bottle.



Fig. 3-7. Assembling the drain tube to the top of the drain bottle.

6. Place the drain bottle on the floor and tape the drain tube to the dryer tube, providing a descent from carriage-level to the drain bottle.

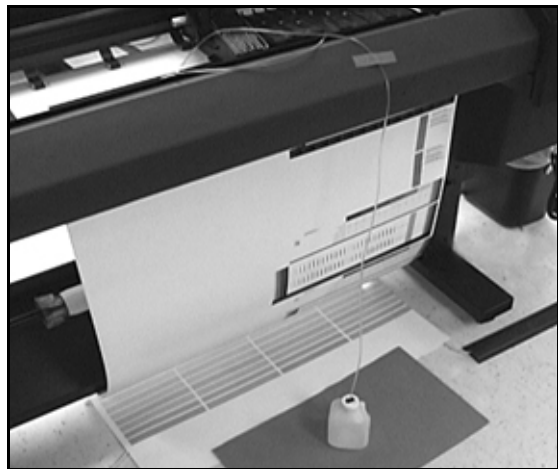

Fig. 3-8. Placing the drain bottle

7. Referring to the Color Map card, place an ink reservoir into its numbered position (1 through 12) in the ink tray.

Be sure to insert the profiler into its port in the ink tray. Work with the ink reservoir, tube, and printhead that correspond to one position at a time. This will help prevent cross-connecting components.

8. Referring to the Color Map card, affix the labels showing the ink color and ink type onto the connectors of the ink supply tube (see Fig. 3-3 on page 3-5).

9. Open one of the carriage covers to expose the printhead slots.

Release the cover by pressing its latch at the front of the carriage.

10. Insert the needle end of the drain tube into the nozzle end of the supply tube that is located in the printhead slot in the carriage assembly (see Fig. 3-9).

This will allow air to escape from the supply tube.

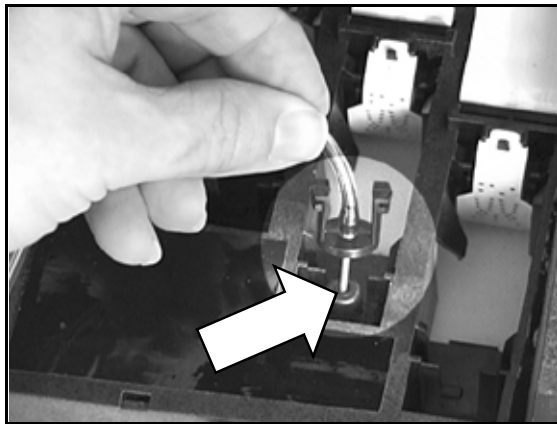

Fig. 3-9. Connecting the drain bottle tube to the supply tube

11. Connect the ink supply tube into its corresponding fitting on the ink reservoir.

The ink will begin to flow from the reservoir toward the ink bottle. The ink will displace the air in the tube, filling it with ink. To ensure that the drain tube needle does not slip out of the ink tube, hold the drain tube needle in place during the fill process.

12. As soon as you see ink flowing into the drain tube, pinch the drain tube and remove it from the nozzle end of the ink tube.

By pinching the drain tube, a vacuum is formed between the pinched tube and the end of the needle, keeping any residual ink from draining from the needle as it is removed.

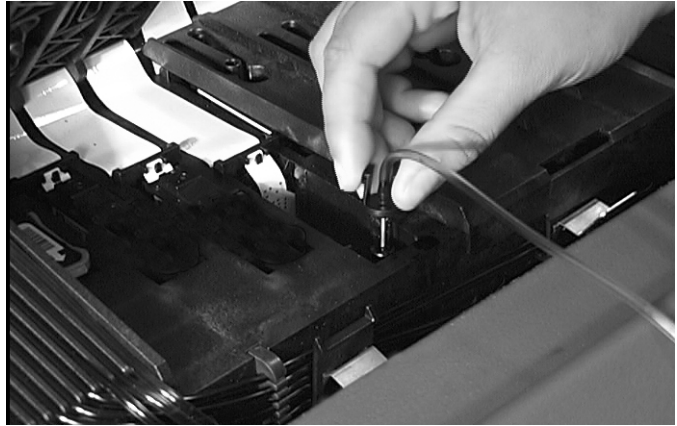

Fig. 3-10. Removing the drain tube

13. Wipe clean the needle end of the drain tube, and set it aside, keeping the ink inside from spilling out.

14. Remove the packaging from a printhead that contains the same ink as the ink reservoir.

Remove the tape covering the electronic contacts, and remove the plug from the ink inlet. Do not touch any of the metallic electronic contacts.

15. Install the printhead into the carriage.

Install the printhead into the correct position. You can use the built-in handle to help position the printhead.

16. Repeat steps 7 through 15 for each ink tube you want to fill.

17. Close and latch the carriage cover(s).

18. Close the printer's top cover.

On the control panel Front Page screen, press the ► (Proceed) key to park the printhead carriage into the service station.

See "Loading Media" on page 3-24 for media loading instructions.

After installing one or more printheads, always run AutoSet. See “Front Page” on page 2-5 for instructions on running AutoSet from the Front Page screen.

Replacing Ink System Components

This section shows you how to replace the individual components in the ink system:

- ◆ Replacing an ink reservoir in an idle printer
- ◆ Replacing an ink reservoir during printing (“hot swapping”)
- ◆ Replacing a printhead
- ◆ Replacing an ink tube

Replacing an Ink Reservoir in an Idle Printer

Replace an ink reservoir when there is insufficient ink to print, or when you want to use a different color or type of ink. If you replace an ink reservoir with the *same* color and type of ink, there is no need to replace the printhead and ink tube.



Caution When switching to a new ink color or ink type, replace the ink reservoir, printhead, and ink tube as a matched set. Failure to do so will contaminate the ink system and compromise performance or output quality.

When installing ink tubes, avoid placing excessive tension on the tube end connected to the printhead. Excessive tension may cause kinking and blockage of the ink flow, and could cause the tube to separate from its connector, resulting in an unrestricted flow of ink from the tube.

1. Remove the ink reservoir from the ink tray. Do not disconnect the ink tube at this time.

This disconnects the profiler, which is built into the ink reservoir, from its port on the back of the tray. The printer detects that the profiler has been disconnected, but will not report an error condition unless you try printing.

2. Install the new ink reservoir into place in the ink tray. Carefully connect the profiler into its port at the back of the tray.

If you install ink of a different color or type than was originally installed, the printer will report this as an error message on the printer control panel.

3. Disconnect the ink tube from the old ink reservoir, and connect it to the new ink reservoir.

Replacing an Ink Reservoir During Printing (“Hot Swapping”)



You can replace an ink reservoir during printing (“hot swap”) only with an ink reservoir of the same color and ink type.

Caution When switching to a different ink color or ink type, wait for printing to finish, then replace the ink reservoir, printhead, and ink tube as a matched set. Failure to do so will contaminate the ink system and compromise performance or output quality.

1. Place the new ink reservoir near the reservoir to be replaced.
2. Remove the ink reservoir from the ink tray. Do not disconnect the ink tube at this time.

This disconnects the profiler, which is built into the ink reservoir, from its port on the back of the tray. The printer detects that the profiler has been disconnected, but will not report an error condition unless you fail to connect the new ink reservoir to the profiler docking station within ten seconds.

3. Install the new ink reservoir into place in the ink tray. Carefully connect the profiler into its port at the back of the tray. Do this promptly. Since the printer keeps track of ink used, the longer it takes for you to replace the ink reservoir, the less accurate this “count” will be. If you install ink of a different color or type than was originally installed, the printer will report this as an error message on the printer control panel, and printing will stop.
4. Disconnect the ink tube from the old ink reservoir, and connect it to the new ink reservoir.

Connect the new ink reservoir within five seconds, or the printhead may deprime, which will damage printed output.

Replacing a Printhead

Replace a printhead when the printer:

- ◆ When the printer can no longer compensate for missing or deflected jets by increasing the number of print passes, and you cannot recover these jets (see “Cleaning Ink Jets” on page 5-3 for instructions).
- ◆ When the number of passes required increases print times to unacceptable levels.
- ◆ When switching ink color or type.

To replace a printhead:

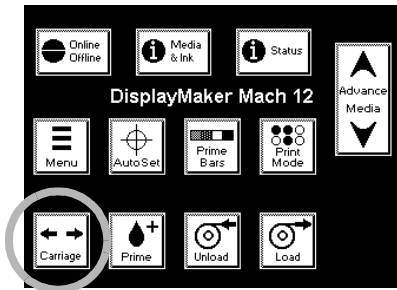

1. Wait for the printer to stop printing.
2. From the ready screen, press the Online/Offline button.
The Front Page screen appears.
3. Press the Carriage button.
The printhead carriage moves out of the service station.
4. Open the top cover.
5. Open the carriage cover of the printhead that you want to replace.
Press the cover's latch at the front of the carriage.
6. Remove the printhead from the carriage by lifting the printhead straight up.
Use the printhead handle to help you lift it up.
7. Install the new printhead into the carriage.
Remove the tape covering the electronic contacts, and remove the plug from the ink inlet.
8. Close and latch the carriage cover.
9. Close the top cover.
10. On the control panel, press the ► (Proceed) key to park the printhead carriage into the service station.
11. Run an AutoSet calibration.

Replacing An Ink Tube

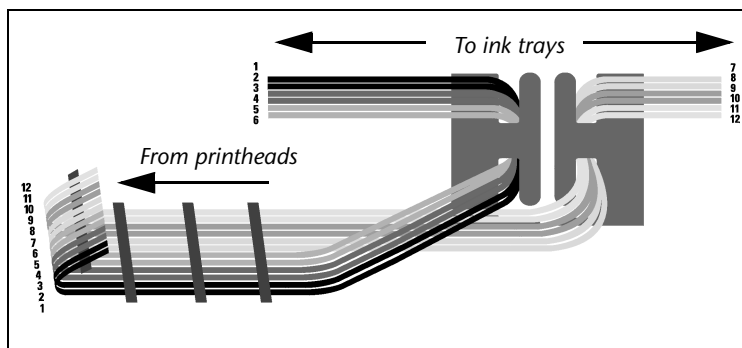

Fig. 3-11. Ink tube routing

Replace an ink tube when switching ink colors or types, or if the ink tube leaks. You need not replace an ink tube when you change an ink reservoir and/or printhead *without* changing ink color or type, if the tube is functioning normally.

Each of the ink tubes is routed to a specific ink tray position, to enable the replacement of individual tubes without crossing or tangling with other tubes.



Caution Always remove and replace ink tubes one at a time, to ensure correct routing of the tube. Although the printer can detect the proper placement of the ink reservoirs and printheads, it cannot detect whether the ink tubes are routed correctly. Incorrectly routed ink tubes would likely mix inks in the printhead, and cause printing problems.



Tip Wear protective gloves during this procedure to protect your hands from ink stains.

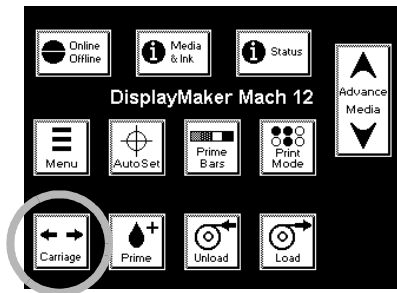

1. Wait for the printer to stop printing.
2. From the ready screen, press the Online/Offline button.
The Front Page screen appears.
3. Press the Carriage button.
The printhead carriage moves out of the service station.
4. Open the printer top cover.
5. Disconnect the ink tube you are replacing at the carriage end.
Some slack is necessary to avoid kinking the ink tube when you disconnect it from the printhead in step 9.
6. Depress the lock levers to unlock the printhead assembly, and swing the carriage up to expose the printheads.
7. Disconnect the ink tube from the ink reservoir.
The tube automatically seals when you disconnect it. This prevents ink from spilling out.
8. Carefully remove the ink tube from its clips, beginning at the ink tray end.
9. Disconnect the ink tube from the printhead.
Unless the tube is damaged, you can store the tube, with the ink inside, for future use. Be sure that it is properly labelled with position number and ink type.
10. Install the new tube into its guides, beginning from the printhead end, but **do not connect the empty tube to the printhead yet.**
Beginning at the printhead end ensures that the slack portion of the tube is at the ink tray end. Be sure to route the

tubes through the guide behind the carriage top cover for printheads 1, 2, and 3.

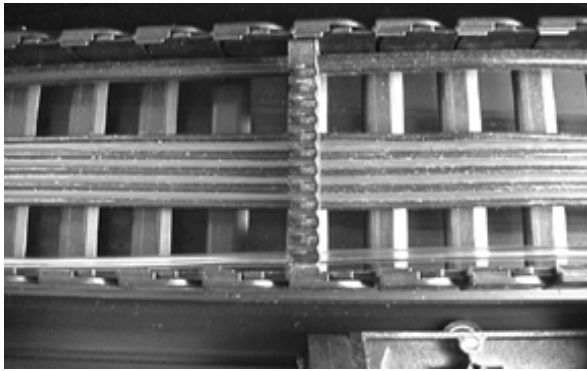

Tube guides inside the tube chain

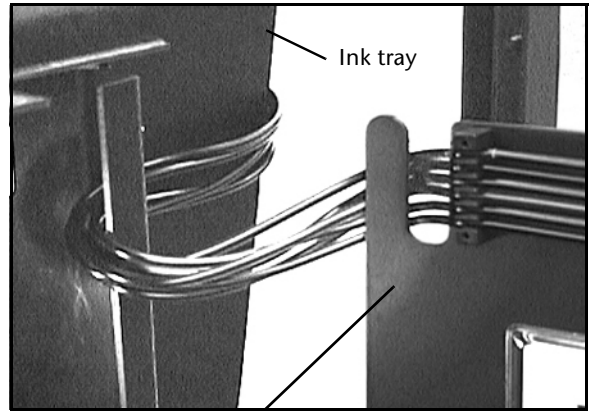

Tube guides along rear of printer

Fig. 3-12. Location of tube guides



Caution Ensure that the ink tubes will not be pinched or severed when the top cover is closed.

11. Connect the new ink tube to the ink reservoir.



Fig. 3-13. Connecting the ink tube to the reservoir



Caution Always fill an empty ink tube with ink before connecting it to a printhead. Attempting to print with an empty ink tube connected to a printhead will result in enough air to be introduced to cause the printhead to fail. This condition may be recoverable by purging the cartridge of air (see “Purging the Print-heads” on page 5-11 for instructions).

12. Connect the other end of the tube to the drain bottle, and place the bottle on the printer platen or floor.

As ink begins to move through the ink tube from the ink reservoir, the air in the tube is displaced with ink. The greater the distance between the drain bottle and the ink reservoir, the faster the ink will flow.



Tip If the ink does not begin flowing, try disconnecting and reconnecting the ink tube to the ink reservoir, and reposition the drain tube needle within the ink tube nozzle.

13. When ink has reached the end of the ink tube and begins dripping into the drain bottle, remove the supply tube from the drain bottle.

The ink tube automatically seals in the ink.

14. Label the new ink tube with the ink color on the connector to the ink reservoir, and with the tube number (1 through 12) on the connector at both ends.

Proper labeling will help ensure that the tubes are always connected to the right ink reservoirs and printheads. This will help reduce the possibility of reconnecting tubes to the wrong printheads.

15. Connect the new ink tube to the printhead.
16. Swing the printhead assembly down into the printing position, and push the printhead assembly down into position until it engages the lock levers with a click.
17. Close the printer top cover.
18. On the control panel Front Page screen, press the ► (Proceed) key to park the printhead carriage into the service station.

Loading Media

Wear cotton gloves during this procedure, or handle the media only by its very outside edges. This will prevent skin oils from being deposited on the media, which could render output quality unacceptable.



Tip For best results, use genuine ColorSpan media.



Caution Do not store or rest a media roll on either end before loading it onto a spool. This could result in an indentation on the edge of the media, which can be struck by the printhead carriage during printing.

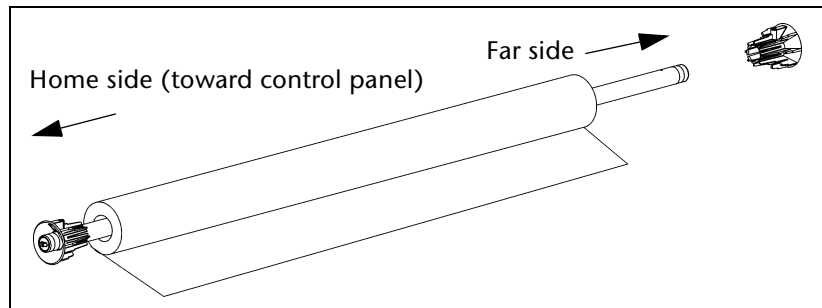

Fig. 3-14. Installing media roll and collets onto the spool

1. Ensure that the fixed collet (with the metal pin) is in the proper location on the supply spool.

The collet is designed to accommodate 2-inch and 3-inch cores.

- ◆ If you are loading media with a 2-inch core, set the collet into the outside (closest to the home side) hole of the spool. This is how the collet is installed at the factory.
 - ◆ If you are loading media with a 3-inch core, set the collet into the inside hole (closest to the far side) of the spool.
2. Tighten the pin with the hex wrench included with the printer.
 3. Load the media roll onto the spool.

4. Load and secure the other collet against end of media roll.
The far-side collet does not have a metal pin. Push the collet into the core, and friction will hold it in place.

5. From the rear of the printer, load the media and spool into the printer's supply spool holder.

Press the home side of the supply spool into the home side holder (on the left from the rear of the printer), then swing the far side of the supply spool into the far side holder (on the right).

6. With your right hand, feed the leading edge of the media into the printer's pinch rollers and hold it in place until the following step.

If loading 72 inch media, see "Loading 72-Inch Media" on page 3-29.



Note The printer automatically locates the right and left edges of the media, so it is not necessary to align the media edges to a reference mark on the platen.

7. With your left hand, press the Media Advance button to advance media a few inches (several centimeters).

The Media Advance button is located to the left of the installed supply spool, on the rear of the printer next to the Big Ink pack tray and electronics enclosure.

8. While holding the left collet stationary, press the Media Advance button a few seconds, until the media web is tight with no wrinkles.

Ensure that the right and left edges of the media web are perpendicular to the sides of the printer, that the tension appears uniform across the media web, and that the media is not unrolling unevenly ("telescoping") from the supply spool.



Note These checks ensure that the tension is uniform across the width of the media. This is critical to trouble-free printing.

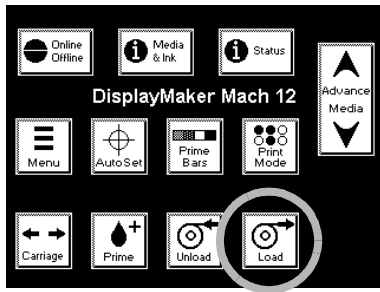

- On the Front Page screen of the control panel, press the Load Media key.

The control panel prompts you to press the ► key to load media, or ✕ to cancel.

- Press the ► key to proceed.

The control panel prompts you to advance the media.

- Press the ▼ key to advance the media past the front edge of the platen.

- Press the ► key to proceed.

This causes the printer to measure the width of the media.

The control panel displays a numeric keypad.

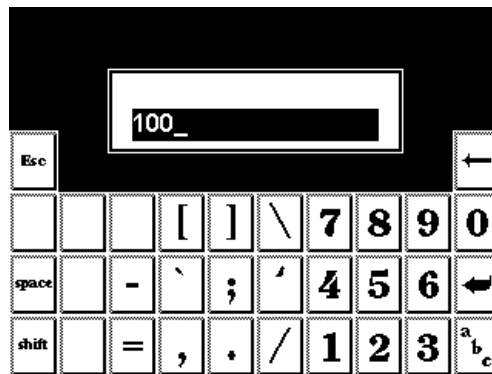

Fig. 3-15. Numeric entry screen

- Enter the length of the media roll (if it is a new roll) or the length remaining (if it is a partially used roll), and press the Enter key to continue.

To skip this step, press Esc or Enter without entering a value. The printer will not track the amount of media remaining on the roll, and it will be unable to display a warning when the amount of media runs low. The media length will display as “undefined.”

14. The control panel asks whether you want to use the takeup system.

See “Takeup Options” on page 3-30 for details on using the takeup system.

- ◆ If you will be printing without using the takeup system, or if you will be performing a Media Feed Calibration, press the **X** key to skip loading the takeup. See “Media Feed Calibration” on page 4-4 for instructions.

- ◆ To use the takeup system, press the **▶** key.

15. Press and hold the **▼** key until the end of the media reaches past the takeup spool.
16. Load an empty media core onto the takeup spool, and load the core and spool into the printer’s takeup spool holder.

See steps 3 through 5 for detailed instructions.

17. Grasping the middle of the media web, pull straight back and tape the middle of the web to the takeup core.



Note Be sure that the direction you wrap the media around the takeup spool is consistent with the direction specified in the Takeup Control option of the menu (see “Takeup Options” on page 3-30 for details). The default direction is Image Outside (printed image facing out).

18. Add a small amount of slack (a “supply loop”) to the media, to prevent the takeup from pulling the takeup spool out of the printer.

19. Press the **▶** key to continue.

The control panel displays an informational message suggesting that you perform a Media Feed calibration.

20. Press the **▶** key to perform a Media Feed calibration, or **X** to skip the calibration.

See “Media Feed Calibration” on page 4-4 for instructions.

You are now ready to begin printing. The printer will verify that the media is wide enough for each print job it receives.



Tip

The media should be consistently tensioned across its width when attached to the takeup spool. Ensure that the web is straight and smooth from side to side. If necessary, a cardboard core from a roll of masking or other graphic arts tape can be slipped over the spool holder to hold it in place.

Loading the media onto a takeup spool that already has some media on it will change the weight of the spool and make it more difficult to inadvertently pull off the media during printing.

Loading 72-Inch Media

The width of the 72-inch media makes it impossible for most persons to load it by grasping its left and right edges at the same time. Follow this procedure to more easily load 72-inch wide media.

Wear cotton gloves during this procedure, or handle the media only by its very outside edges. This will prevent skin oils from being deposited on the media, which could render output quality unacceptable.

1. With your right hand, grasp the media at the center of its leading edge, and pull it forward into the center grip rollers.
2. While continuing to hold the center of the leading edge of the media in place, grasp the left edge of the media with your left hand.
3. Pull the left edge of the media into the leftmost grip rollers.
4. Hold the media in place with your left hand.
5. Grasp the right edge of the media with your right hand, and pull it into the rightmost grip rollers.
6. With both hands, feed the media web evenly into all grip rollers.
7. Press the Media Advance button to finish loading the media.
8. Verify that the media web is even and unwrinkled across its width.
9. When loading the media onto the takeup spool, ensure that the media is tightly wound onto the spool across its width.

Uneven or excessive tension may cause the spool to pull out of the left spool holder.

Takeup Options

You can enable and disable the takeup system at the control panel. See Takeup Control under “Print Settings” on page 2-11 for details.

- ◆ **When enabled**, before each print job the takeup system automatically detects whether any media is attached to the takeup spool and operates the takeup motor as needed.
- ◆ **When disabled**, the takeup motor will not operate, and will not attempt to detect whether media is attached to the takeup spool.

When printing one print at a time, you may choose to not use the takeup system at all. In this case, advance the media, cut the finished print from the roll, then back up the media for the next print. (To advance and back up the media using the control panel, see “Front Page” on page 2-5).



Caution

If you do not use the takeup system, the software assumes that you are cutting individual prints as they are printed. If you send a large number of jobs to the printer without the takeup system loaded, and allow printing to continue unattended, the prints will pile onto the floor.

You can also configure the takeup system so it winds the image facing to the inside or outside of the spool. This is useful if your laminator or other finishing equipment has a certain requirement for its supply spools. See Takeup Control under “Print Settings” on page 2-11 for instructions.

Linearization

When changing media types, you should perform a color calibration or linearization (if supported by the RIP). This compensates for the differences between medias that affect color accuracy. For further information, see “Linearization” on page 4-23.

When replenishing the media supply with the same type of media, relinearization is unnecessary unless print color quality has changed noticeably.

Dryer Operation

As the printed output advances past the dryer outlets, the dryer blows air over the output to dry it. The print will continue to advance until the trailing edge of the print has passed under the dryer. The print remains stationary for twenty seconds, then will reverse or advance according to the supply loop option selected (see page 2-14). To cancel the twenty-second delay, press the **X** (Cancel) key.

The printer's relative humidity sensor enables the printer to adjust the media advance speed to ensure adequate drying. Higher relative humidity will result in slower printing. You can customize this feature from the control panel; for instructions, see page 2-12.

Relative Humidity	Printer Action
0-29%	Low humidity warning displayed, jets may drop out and media may lift from the platen
30-59%	Optimal, no warning or drying delay
60-79%	High humidity warning displayed, media advance is delayed automatically as humidity increases
> 80%	Action displayed, printing stops. User must specify a manual drying delay to proceed with printing (see Drying Delay under "Print Settings" on page 2-11)



Caution	Output on polyester films can be streaked by the dryer air flow. To avoid this, you can disable the dryer fan from the control panel. For instructions, see "Printer Options" on page 2-13.
----------------	---

Cutting and Unloading Media

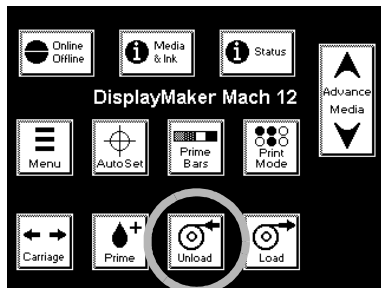

1. Press the ▼ key on the Front Page screen to advance the printed portion of the media past the cutter anvil (on the front edge of the platen).
2. From the front of the printer, place a utility knife blade in the cutter channel and draw the cutter across the media.

Support the trailing edge of the media as you cut it from the supply spool.

3. On the Front Page screen of the control panel, press the Unload Media key.
4. The control panel prompts you to press ► to unload media, or ✕ to cancel.
5. Press ► to continue.

The control panel asks if you want to print the calculated length of media remaining on the supply spool onto the media for reference. When reloading the media later, the control panel will prompt you to enter this value so it can continue to track the amount of media remaining.

6. Press ► to print the length remaining, or ✕ to skip printing.
7. As desired, take the single print or takeup spool with printed output to your finishing area, and re-load the takeup system.

CHAPTER 4

Calibrating the Printer

This chapter explains how to calibrate the printer for the best possible output:

- ◆ AutoSet (page 4-2)
- ◆ Manual Calibrations (page 4-3) — Media Feed, Manual BiDi Registration, Manual Head Registration, Manual Jet Mapping, Jet Status Lines, Default Registration Data
- ◆ Auto Calibrations (page 4-19) — AutoBiDi Calibration, AutoH2H (Head-to-Head) Calibration, AutoBiDi & H2H Calibration, AutoJet Calibration
- ◆ AutoTune (page 4-20)
- ◆ Calibration Summary (page 4-21)
- ◆ Linearization (page 4-23)

AutoSet

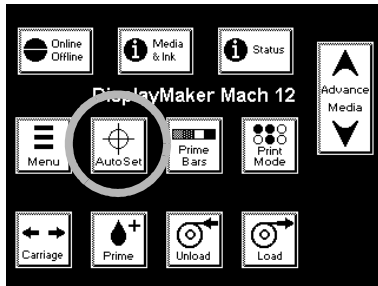

AutoSet is an advanced printer calibration feature that uses an onboard digital imaging sensor and sophisticated software to detect and compensate for variations in ink jet printing. It can be initiated by the user or run automatically at specified intervals (AutoTune). AutoSet is designed to be a “one-button” calibration, the only calibration you need to run in most cases for superior quality output.

When you press the AutoSet key on the Front Page control panel screen, these functions are performed automatically:

- ◆ **Bidirectional Registration** — ensures that every working jet fires a pixel at precisely the same location, regardless of the carriage’s direction of travel.
- ◆ **Head-to-Head Registration** — ensures that the printheads are in alignment relative to each other.
- ◆ **Autojet substitution mapping** — detects and disables individual ink jets that are misfiring or not firing at all. During subsequent printing, the printer compensates for these jets by using other jets in their place, ensuring maximum print quality without reducing print speed.



Note Clean printheads produce the best printed output and accurate calibration patterns.



Note AutoSet does not work with transparent media. In this case, you should run AutoSet on a white media that is similar in thickness to the clear media, then switch to the transparent media; or manually run the calibrations under the Calibrate Printer menu using the transparent media.



Tip If the printhead carriage head height is set to 0.070 inches (1.78 mm) or higher, do not run AutoSet. For best accuracy, run the manual calibrations instead. For instructions on running the manual calibrations, see “Manual Calibrations” on page 4-5.

Manual Calibrations

When you run the calibrations from this menu, you evaluate the calibration test patterns visually and enter the calibration values via the control panel. In most cases, AutoSet is more accurate and should be used instead (see “AutoSet” on page 4-2).



Note Manually performing the component calibrations of AutoSet is time-consuming and can be error-prone, but is necessary when the head height is 0.070 inches (1.78 mm) or greater, or when calibrating transparent media. (There is no automatic media feed calibration, so you must always perform it manually.)

If you decide to manually calibrate the printer, first clean the printhead jets as described in “Cleaning Ink Jets” on page 5-3.

The Manual Calibration menu consists of these options:

- ◆ **Media Feed** (page 4-4) – enables you to calibrate the printer’s media advance accuracy by printing and visually inspecting your choice of test patterns.
- ◆ **Manual BiDi Registration** (page 4-7) – prints bidirectional registration patterns and allows you to report which pattern is the most precise.
- ◆ **Manual Head Registration** (page 4-10) – precisely aligns the printheads relative to each other, for accurate colors and precise registration of images.
- ◆ **Manual Jet Mapping** (page 4-13) – enables you to detect and report nonfiring or misfiring ink jet nozzles, which enables the printer to “fill in” for them.
- ◆ **Jet Status Lines** – prints a quick test pattern that shows which jets are out.
- ◆ **Default Registration Data** – sets all registration data to zero.

After calibration and jet mapping, perform a linearization, or color calibration (as supported by your print server or RIP). For further information, see “Linearization” on page 4-23.

Media Feed Calibration

This calibration allows you to calibrate the accuracy of the media feed process. You perform this calibration when loading media, or later if prints requiring very accurate length (for example, output that will be tiled) are found to be the wrong length.

To perform this procedure, it is helpful to have a magnifying glass or printer's loupe to examine the test patterns.

- ◆ **Before** performing a Media Feed calibration, print the Prime Bars and clean the ink jets to get the maximum number of jets working.

- ◆ **After** performing a Media Feed calibration, run AutoSet.

1. If you will be performing this calibration with a new roll of media, advance the media to the floor, back it up to the platen, and remove the supply loop (see page 2-13).

This will remove the advance error that would be introduced by the tighter winding at the beginning of a new roll of media.

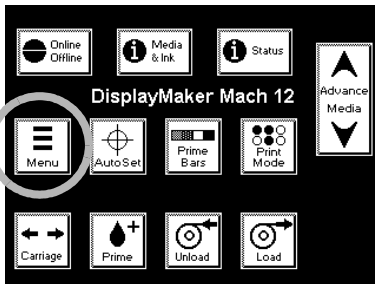

2. Press the  (Menu) key from the Front Page screen on the control panel to display the menus.

3. Press the  (Menu In) key display the Calibrate Printer menu.

4. Press the  key to highlight Manual Calibration.

5. Press the  (Menu In) key.

6. Press the  (Menu In) key to select the Media Feed option.

The following prompt appears:

Press Proceed to print pattern
Press Cancel to adjust without printing

7. Press the Proceed key to print a test pattern, or Cancel to skip printing.

If you press Cancel, to go step 13.

When you press Proceed, you can choose between the following calibrations:

- ◆ **34-Inch (900 mm) Calibration** — prints two reference marks along the direction of media feed; measure the distance between the marks to determine advance accuracy.

- ◆ **12-Inch (305 mm) Calibration** — same as previous calibration, uses less media but may be less accurate.

- ◆ **Double Lines** — alternate method for use when a reference measuring stick is not available

8. Select one of the options and press the **↵** (Menu In) key to continue.
9. Follow the applicable procedure below.

34-Inch/12-inch Calibration

10. Press the **▶** key to continue.

The printer asks whether you want to print the media feed calibration.

11. Press the **▶** key to continue.

The printer prints the calibration marks, and prompts you to adjust the advance.

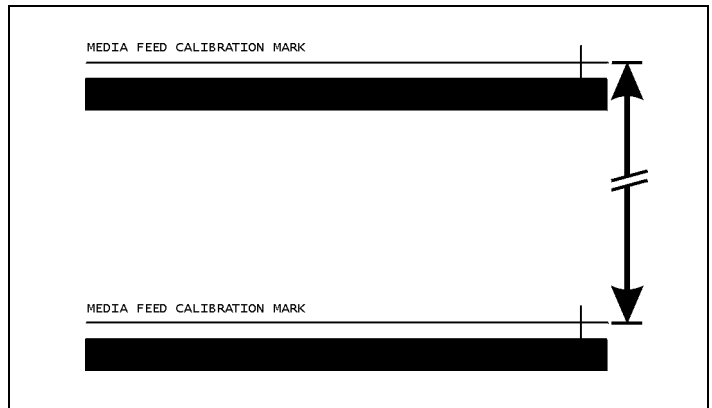

Fig. 4-16. Media Feed Calibration pattern

12. With a metal yardstick, measure the distance between the marks.
A measuring stick with 1/64 inch markings works best.
13. Adjust the media feed advance using the control panel.
You can increase the advance by pressing the **▲** key, or decrease it by pressing the **▼** key.
14. Press **▶** (Proceed) to save the advance value you entered.
15. Press **▶** (Proceed) to return to the menu.

Double Lines Calibration

Use this calibration if an accurate measuring stick is not available.

The panel prompts you to select a printhead to calibrate.

16. Scroll through the printhead numbers to the printhead you want to calibrate, then press the ► key.

A menu appears listing the pattern versions plus a cancel option:

- ◆ Fine
- ◆ Medium
- ◆ Coarse
- ◆ Cancel Calibration

Begin with the Coarse pattern, and repeat this procedure with the Medium and Fine versions for the best results.

17. Select a pattern and press the ► key to proceed.

If prompted, remove the supply loop (see page 2-13). The pattern you selected prints.

18. Examine the patterns with a high-power magnifier.

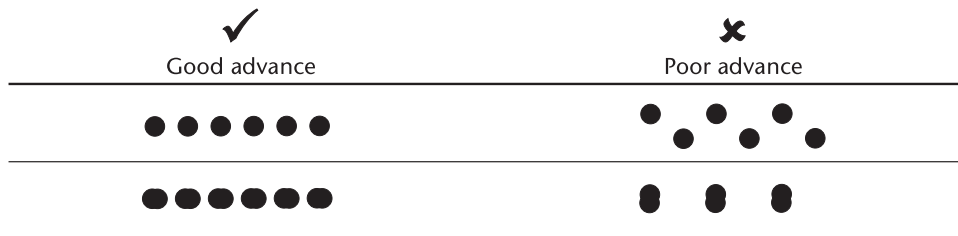

Fig. 4-17. Good advance and bad advance in media advance calibration patterns

19. Select the pattern with the straightest line of pixels, and enter the pattern number.

Manual Bidirectional Registration

Bidirectional registration is a method to align each of the print-heads so that dot placement is accurate in both directions along the X axis (along the direction of print head travel).

The bidirectional registration pattern consists of a series of vertical lines. Half the pixels in this pattern are printed in one direction, half of them in the other direction. When the pixels are accurately aligned, the pattern is clear. When the dots are not aligned, the pattern appears fuzzy and ill-defined.



Tip AutoSet incorporates an automatic version of this calibration. Try AutoSet first before running this manual calibration (see “AutoSet” on page 4-2 for details).

There are three bidi patterns from which to choose:

- ◆ **Fine** — allows 0.25 pixel adjustments
- ◆ **Medium** — allows 0.5 pixel adjustments
- ◆ **Coarse** — allows 1 pixel adjustments

For the most precise image reproduction, perform these calibrations one after the other, starting with Coarse, then Medium, then Fine.

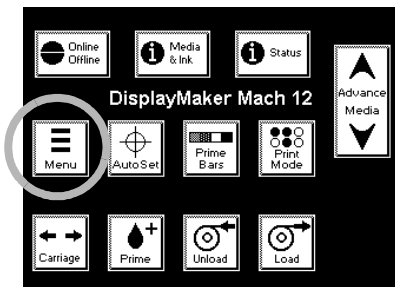

1. Press the (Menu) key from the Front Page screen on the control panel to display the menus.
2. Press the (Menu In) key display the **Calibrate Printer** menu.
3. Press the key to highlight **Manual Calibrations**.
4. Press the (Menu In) key.
5. Press the key to highlight **Manual BiDi Registration**.
6. Press the (Menu In) key to select the option.
7. Press (Proceed).

The control panel displays this prompt:

Print a manual bidi registration page?

8. Press (Proceed).
9. Press the key repeatedly to highlight the **Fine, Medium, or Coarse** option.

10. Press ► (Proceed).

The printer prints the calibration pattern you selected.

11. When the calibration page has printed, the control panel displays this prompt:

BiDi registration
Head 1: 0

12. Examine the BiDi Registration pattern for the current head, and determine which pattern is the closest to perfectly aligned.

Use a printer's loupe to select the pattern, since the lines in the patterns may be difficult to discern.

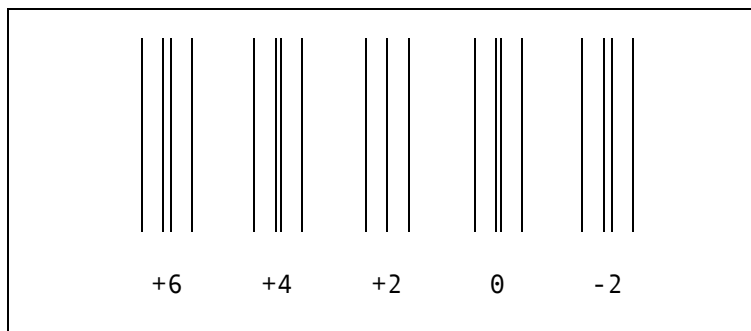

Fig. 4-18. BiDi Registration pattern.

13. Press the ▲ or ▼ control panel keys repeatedly until the number next to the pattern that is closest to aligned perfectly is displayed.

For example, if pattern +2.0 is the closest aligned, press the ▲ key to change the display to:

HEAD-1 +2.0

If a printhead is extremely out of alignment, there may be no pattern in alignment. Since the black vertical bars are nominally five pixels apart, you can add +5 or -5 to a pattern number to shift the colored bars right or left by one black bar. Alternatively, you can perform the BiDi Registration repeatedly, which will move the head in smaller increments, until the head is aligned.

14. Press ► (Proceed).

The control panel message increments the head number by one.

15. Repeat steps 12 through 14 for each of the twelve heads.
When you have entered registration values for all heads, the control panel displays this message:

Registration Successful

Manual Head Registration

The printer creates images by firing dots of ink onto a sheet of media. Precise positioning of each dot is essential for optimal print quality. This is possible only if you register all printheads in the printhead assembly to each other in both the **X** (along the length of the platen) and **Y** (along the length of the media) directions.

This is a two-part process:

- ◆ Print a registration pattern.
- ◆ Enter the X and Y registration data for each head.



Tip AutoSet incorporates an automatic version of this calibration. Try AutoSet first before running this manual calibration (see “AutoSet” on page 4-2 for details).

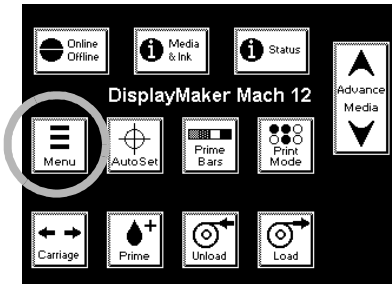

1. Press the **≡** (Menu) key from the Front Page screen on the control panel to display the menus.
2. Press the **↶** (Menu In) key display the **Calibrate Printer** menu.
3. Press the **▼** key to highlight **Manual Calibration**.
4. Press the **↶** (Menu In) key.
5. Press the **▼** key to highlight **Manual Head Registration**.
6. Press the **↶** (Menu In) key to select the option.

The control panel asks whether you want to print a manual head-to-head calibration page.

7. Press the **▶** key.

The control panel displays a menu to allow you to select a Fine, Medium, or Coarse registration pattern.

8. Press the **▼** and **▲** keys to select a pattern, then press the **▶** key.

If you have a calibration pattern from a recent print, you can use it to calibrate the heads. Press **✕** (Cancel) and go to step .

If you need to print a new calibration pattern, press ► (Proceed). The printer prints a calibration page.

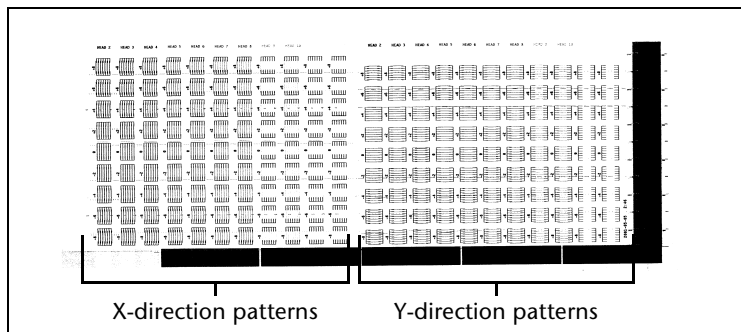

Fig. 4-19. Head-to-Head Registration patterns

When the calibration page has printed, the control panel displays this prompt:

Take readings from left side of pattern.

9. Press the ► key.

The control panel displays this message:

X Direction Registration
Head 2: +0

10. Examine the X direction pattern (in the left-hand group of patterns) for the current head, and determine which pattern of colored and black lines are the closest to perfectly aligned.

Use a printer's loupe to select the pattern, since the lines in the patterns may be difficult to discern otherwise.

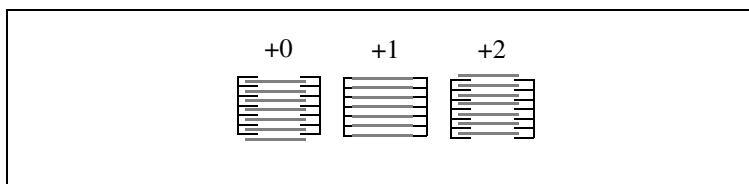

Fig. 4-20. Sample head calibration patterns.
In this example, pattern "+1" is aligned the closest, so "+1" would be entered.

11. Press the ▲ or ▼ control panel keys repeatedly until the number next to the pattern that is closest to aligned perfectly is displayed.

For example, if pattern +2 is the closest aligned, press the ▲ key to change the display to:

X REG
HEAD-1 +2

If a printhead is extremely out of alignment, there may be no pattern in alignment. Since the black vertical bars are five pixels apart, you can add +5 or -5 to a pattern number to shift the colored bars right or left by one black bar. Alternatively, you can repeatedly perform an X calibration, which will move the head in smaller increments, until the head is aligned.

12. Press ► (Proceed).

The control panel message increments the head number by one.

13. Repeat steps 10 through 12 for each of the heads.

When you have entered registration values for all the heads, the control panel displays this message:

Take readings from right side of pattern.

14. Press the ► key.

Y Direction Registration
Head 2: 0

X registration is complete. You are now ready to begin Y registration.

15. Examine the Y registration pattern (in the right-hand group of patterns) for the current head, and determine which pattern of colored and black lines are the closest to perfectly aligned.
16. Press the ▲ or ▼ control panel keys repeatedly until the number next to the pattern that is closest to aligned perfectly is displayed.
17. Press ► (Proceed).

The control panel message increments the head number by one.

18. Repeat steps 15 through 17 for each of the Y patterns.

When you have entered registration values for all of the patterns, the control panel displays this message:

Registration successful.

Manual Jet Mapping

Each of the printheads used by the printer has 512 ink jet nozzles (jets). If any one of these jets is clogged or has a bad electrical connection, print quality may be affected. A certain number of non-firing jets is within the performance specifications of most printers that use this technology.

Using a patent-pending technique, the printer “fills in” the pixels that were not printed by the non-firing jets, without reducing print speed. The end result is that every print is made with no missing pixels.

The printer automatically maps out missing jets that are not firing for electrical reasons. Jets that are missing or misfiring for other reasons are usually detected during the AutoSet or AutoJet calibrations. You may also map jets manually using the following procedure.







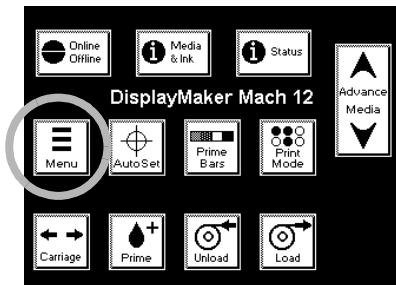

Tip AutoSet incorporates an automatic version of this calibration. Try AutoSet first before running this manual calibration (see “AutoSet” on page 4-2 for details).



Tip For best results, before performing this procedure, clean the printhead jets as described in “Cleaning Ink Jets” on page 5-3. Autodetected missing jets sometimes can be recovered by carefully wiping the electrical contacts on the printhead and their corresponding contacts on the printhead carriage with a lint-free wipe moistened with plain water.



1. Press the  (Menu) key from the Front Page screen on the control panel to display the menus.
2. Press the  (Menu In) key display the **Calibrate Printer** menu.
3. Press the  key to highlight **Manual Calibration**.
4. Press the  (Menu In) key.
5. Press the  key to highlight **Manual Jet Mapping**.
6. Press the  (Menu In) key to select the option.

The control panel displays this message:

Print Jet Map
Page 1 of 2 now?

If you have a calibration pattern from a recent print, you can use it to calibrate the heads. Press **X** (Cancel) and go to the next step. Otherwise, press **▶**.

The printer prints a jet map test pattern for printheads 1-6.

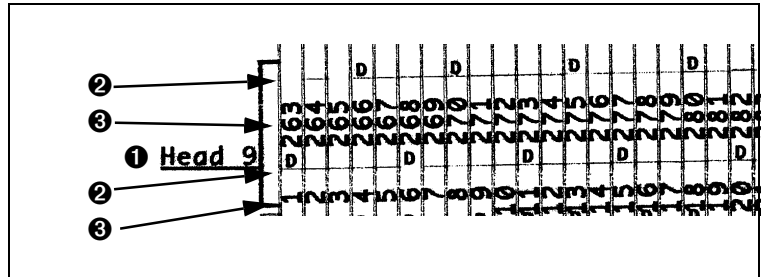

Fig. 4-21. Sample jet mapping pattern

- ① Head number
- ② Test pattern and codes
- ③ Jet number

- ◆ If a line segment is missing or broken, the jet listed in the same column is out. In Fig. 4-21, jets 263 and 265 are out.
- ◆ If a line segment is marked with a code letter, it has already been detected by the software, so no further action by you is required. This data, however, may be requested by MacDermid ColorSpan Technical Services (phone: 800-925-0563) to help diagnose printing problems.



Note

If this test auto-detects (marks with an E) that more than twelve jets are missing on any one printhead, the printhead may be improperly seated. Try reseating the printhead, and print another Jet Coverage pattern.

7. When the calibration pattern has printed, the control panel displays a menu with the following options:
 - ◆ **Report individual bad jets** – enables you to report a bad jet.
 - ◆ **Clear individual bad jets** – enables you to clear (mark as good) a jet.
 - ◆ **View current bad jets** – lists the bad jets on a given printhead.

- ◆ **Clear all bad jets** – clears (marks as good) all jets currently marked as unusable.

Select an option and follow the corresponding procedure below.

Report Individual Bad Jets

When you select Report Individual Bad Jets, the control panel displays the following prompt:

Head 1:
Press Proceed to report a bad jet.

8. Press ▲ and ▼ to select a head number, then press ► (Proceed).

The control panel displays a numeric keyboard that you can use to enter the number of the bad jet.

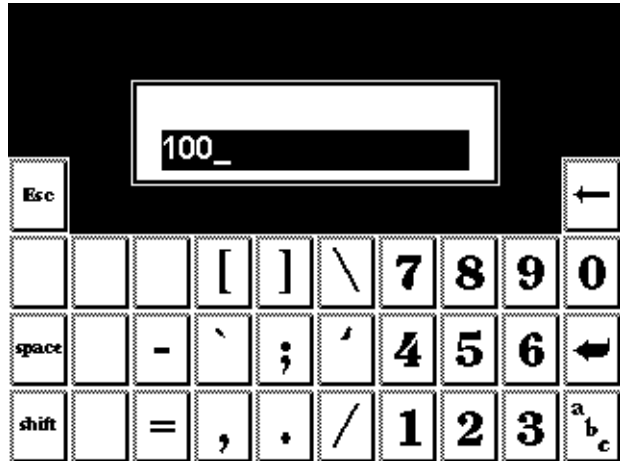

Fig. 4-22. Numeric entry screen

9. Enter the jet number, then press the Enter key.
10. When you are finished entering jet numbers, press the Esc key.

The control panel displays the head selection message again.

11. Press ▲ and ▼ to select the next head number, then press ► (Proceed).
12. Repeat steps 9 through 11 for each head containing bad jets you want to report.

13. When you are finished reporting bad jets, press **X**.
The control panel displays the previous menu.

Clear Individual Bad Jets

When you select Clear Individual Bad Jets, the control panel displays the following prompt:

Head 1:
Press Proceed to clear a bad jet.

14. Press **▲** and **▼** to select a head number, then press **▶** (Proceed).

The control panel displays a numeric keyboard that you can use to enter the number of the bad jet.

15. Enter the jet number, then press the Enter key.
16. When you are finished entering jet numbers, press the Esc key.
The control panel displays the head selection message again.
17. Press **▲** and **▼** to select the next head number, then press **▶** (Proceed).
18. Repeat steps 15 through 17 for each head containing bad jets you want to clear.
19. When you are finished clearing bad jets, press **X**.
The control panel displays the previous menu.

View Current Bad Jets

When you select View Current Bad Jets, the control panel displays the following prompt:

Head 1:
Press Proceed to view bad jets.

20. Press **▲** and **▼** to select a head number, then press **▶** (Proceed).

The control panel displays a message that lists the bad jets by number.

21. Press **▶** to return to the head selection screen.
22. Repeat steps 20 and 21 for each head you want to check for bad jets.
23. When you are finished clearing bad jets, press **X**.

The control panel displays the previous menu.

Clear All Bad Jets

When you select Clear All Bad Jets, the control panel displays the following prompt:

Are you sure you want to clear
ALL reported bad jets?

- ◆ Press **X** to cancel this function, or
- ◆ Press **▶** (Proceed). The control panel displays this message:

All reported bad jets have been cleared.

24. Press **▶**.

The following prompt appears:

Print Jet Map
Page 2 of 2 now?

25. Press **▶**.

26. Repeat steps 7 through 24.

When you have finished mapping jets, the following summary appears on the control panel:

x jets currently reported bad.
x new bad jets reported.
x previous bad jets cleared.

where x is the number of jets.

Jet Status Lines

This option prints a test pattern that shows which jets are working, and which jets are out.

Zero Registration Data

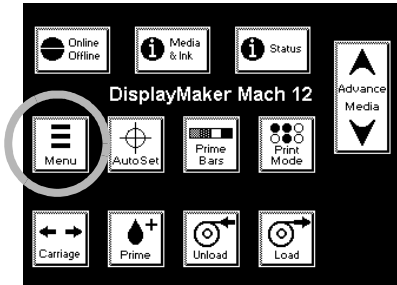

This option resets all registration data. Since there is no registration data after running this option, all calibration values must be reestablished by running the calibrations.

Auto Calibrations



AutoSet is a convenient “one button” action to automatically run three different calibrations, but you can also run each one individually, from the Auto Calibrations menu.

To evaluate the calibration test patterns visually and enter the calibration values via the control panel, run the Manual Calibrations. For instructions, see “Manual Calibrations” on page 4-3.

1. On the Front Page screen, press the  (Menu) key to enter the menu system.
2. Press the  (Menu In) key display the **Calibrate Printer** menu.
3. Highlight **Auto Calibrations** and press the  (Menu In) key.
4. Select one of the Auto Calibrations.
 - ◆ AutoBiDi Calibration
 - ◆ AutoH2H (Head-to-Head) Calibration
 - ◆ AutoBiDi & H2H Calibration
 - ◆ AutoJet Calibration

AutoTune

AutoTune runs AutoSet automatically at intervals you specify. When you use the AutoTune scheduler to run AutoSet, AutoSet always performs its three calibrations without prompting the user or canceling due to too many bad jets. You can use the Quality Check Mode feature to handle AutoSet errors, with or without user intervention.

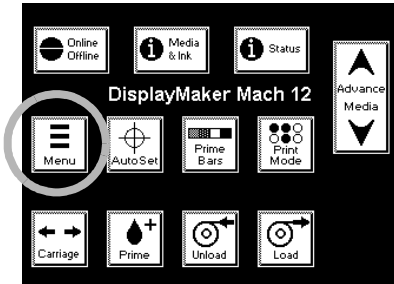

To run AutoSet at specified intervals (AutoTune):

1. On the Front Page screen, press the **≡** (Menu) key to enter the menu system.
2. Press the **↶** (Menu In) key display the **Calibrate Printer** menu.
3. Press the **▼** key to highlight **AutoTune**.
4. Press the **↶** (Menu In) key.

The control panel prompts you to specify an AutoTune interval.

5. Press **▶** (Proceed).

The control panel displays this message:

Run AutoSet every 0 prints.

6. Press the **▲** key repeatedly to increment the AutoTune interval to the number of prints you desire.
7. Press **▶** (Proceed).
8. Press the **↷** (Menu Out) key repeatedly until the Front Page screen is displayed. Press the Online/Offline button to return the printer to the Ready state.

Quality Check Mode

When you run AutoSet manually, the software notifies you if there are any jet or alignment problems so that they can be addressed. When AutoTune runs AutoSet at scheduled intervals, you can use the Quality Check Mode feature to handle AutoSet errors. For instructions on setting the Quality Check Mode, see page 2-13.

Calibration Summary

These options allow you to print a summary of the AutoSet calibration, or transmit calibration data to a log file on the print server.

- ◆ **AutoSet Summary** – when enabled, a table of the results of the AutoSet calibration is printed after the AutoSet test patterns:
- ◆ **Log Head Registration Data** – sends head registration data to a log file on the print server.
- ◆ **Log Jet Data** – sends jet data to a log file on the print server.

The AutoSet Summary contains the following data:

Ink Sample	Sample color block, for identification only (not a print quality test).
Head	Printhead position for the printhead.
Profiler/Pen Present	The ink color of the profiler, which is integral to the ink reservoir.
Cartridge OK	Printhead passed all calibrations (Y), or failed one or more calibrations (N).
Total Bad Jets	The number of missing and deflected jets on the printhead. Use this number and the Jets Disqualified, Jets Out, and Jets Unfixed numbers to evaluate cartridge performance.
Sabre Angle	Troubleshooting data for MacDermid ColorSpan Technical Support.
Head-to-Head Registration	“OK” indicates that the printhead was successfully registered. Any other code indicates an error.
Bidirectional Registration	“OK” indicates that the printhead was successfully registered. Any other code indicates an error.
AutoJet Registration	“OK” indicates that the printhead was successfully registered. Any other code indicates an error.
Jets Disqualified by AutoJet Jets Out for X Offset Jets Out for Y Offset	Indicates the total number of jets disqualified.

Jets Unfixed	For each print pass mode, shows the number of unfixed jets on each print-head. This number should be zero for all printheads.
CP Codes	Carriage and Pen Check Codes, for troubleshooting by MacDermid ColorSpan Technical Support.

Linearization

As the density of an image varies from highlights to shadows, or from lighter tints to darker tints, the printer should accurately reproduce these areas in a predictable, or linear, fashion. The process of linearization (or color calibration) involves printing and reading color test patches, and calibrating the printer to ensure that the expected and printed densities will match. This in turn will ensure optimal color matching.

You should perform a linearization when:

- ◆ You notice a shift (change) in color output
- ◆ Changing ink types or sets
- ◆ Changing media types
- ◆ Changing print mode (only if the most precise color matching is required)

Linearization is a feature of the print server or RIP connected to the printer. Refer to the documentation that accompanies the print server for further information.



Tip

For best results, be sure that the linearization patches are dry before taking readings. Use the printer's dryer with heat to ensure complete drying.

CHAPTER 5

Maintaining the Printer

This chapter describes how to maintain the printer:

- ◆ Maintenance Schedule (page 5-2)
- ◆ Cleaning Ink Jets (page 5-3)
- ◆ Cleaning the Service Station (page 5-5)
- ◆ Printing Prime Bars (page 5-7)
- ◆ Manual Priming (page 5-8)
- ◆ Cleaning the Top Cover (page 5-10)
- ◆ Purging the Printheads (page 5-11)
- ◆ Cleaning the Encoder (page 5-13)
- ◆ Cleaning the Carriage Rail (page 5-14)

Maintenance Schedule

The following types of maintenance are recommended:

- ◆ Daily and “as needed” maintenance
- ◆ Printing interval warning – the printer maintains a periodic maintenance clock that tracks the total amount of time the printer has spent printing. After the periodic maintenance interval has been reached, the ATTN key will appear on the control panel, and the user will be advised to perform the periodic maintenance items described in this chapter. When you dismiss the warning message, the maintenance clock is reset. The printer does not verify that the periodic maintenance is actually performed.
- ◆ 2000 ml printhead purge

See the following table and the remainder of this chapter for details and instructions.

Item	Action
Interval: Daily	
Printhead jets	Clean (see page 5-3)
Service station	Clean (see page 5-5)
Ink tubes	Inspect for kinks, potential snags or tangles
Pinch rollers	Inspect for ink, dust buildup
Carriage rail	Inspect for ink, dust buildup
Interval: As needed	
Print prime bars	See page 5-7
Manual priming	See page 5-8
Top cover cleaning	See page 5-10
All printheads in use	Purge air or replace printheads (see page 5-11)
Interval: When printing interval warning appears	
Encoder strip	Clean (see page 5-13)
Carriage rail	Clean (see page 5-14)
Service station	Clean (see page 5-5)
Spools and collets	Inspect for slippage, reposition and tighten collet screws if necessary

Cleaning Ink Jets

Maintenance interval: daily.

Before running AutoSet, which compensates for missing and misfiring ink jets, you should clean the jets as described in the following paragraphs to help keep them clear of accumulated ink.

The effectiveness of the high-resolution printing process used by the printer can be impaired by printheads that are improperly maintained. Partially clogged nozzles may cause the jets to misfire intermittently, or deflect ink slightly in the wrong direction.

Cleaning the ink jets daily should be sufficient in most cases. Cleaning will likely be required more often if the printer sits idle for extended periods.

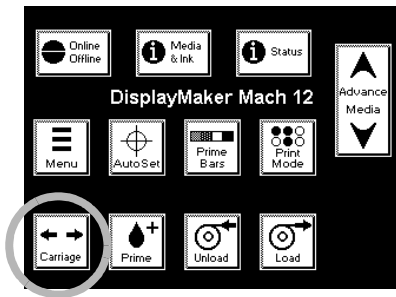

1. From the Front Page screen of the control panel, press the Carriage key.

The carriage moves out from the service station and stops.

2. Open the printer's top cover.
3. Depress the lock levers to unlock the printhead assembly, and swing up the carriage to expose the ink jets.
4. Gently wick the ink jet nozzles with a nonfibrous, lint-free swab moistened with water. **DO NOT USE ALCOHOL**, use plain water.

If you find excessive buildup on the bottom of the printhead, clean off the excess using a moistened pad, and then wipe the bottom of the printhead with the swab.



Caution Do not touch the contacts or orifice plate (jet nozzles) with your bare fingers. Also, take care not to use excessive force when wiping the printheads with the swabs or pads.

5. Close the printer's top cover.
6. Swing the printhead assembly down into the printing position, and push the printhead assembly down into position until it engages the lock levers with a click.

7. Clean the service station as described in “Cleaning the Service Station” on page 5-5.
8. On the control panel Front Page screen, press the ► (Proceed) key to park the printhead carriage into the service station.

Evaluating Printhead Performance After Cleaning

The Jet Status Lines test provides a quick method of determining the effectiveness of (or the need for) cleaning. This test prints a pattern of lines, each segment of which corresponds a single jet. If there are any missing segments in the lines, then a cleaning is recommended. If, however, the lines appear solid and consistent, then cleaning is most likely not required at this time.

The Jet Status Lines function is on the Calibrate Printer - Manual Calibrations menu.

Cleaning Jet Outs

If output, prime bars, or calibrations indicate excessive missing jets (jet outs), try recovering these jets as follows:

1. Fill a small ultrasonic jewelry cleaner with hot tap water.
2. Place the printhead in ultrasonic cleaner, until just the jet orifice plate is submerged, for five minutes.
3. Purge 5-10 ml of ink from the printhead.

Call MacDermid ColorSpan Technical Services for further information and the latest proven cleaning techniques.

Cleaning the Service Station

Maintenance interval: daily, and when switching between dye and pigment inks.

Cleaning the service station helps to prevent dried ink from clogging the ink jets. Keep a replacement set of boots and wipers on hand to replace damaged or worn boots and wipers. Order a replacement kit, ColorSpan part number 0900782, which includes twelve boots and twelve wipers.

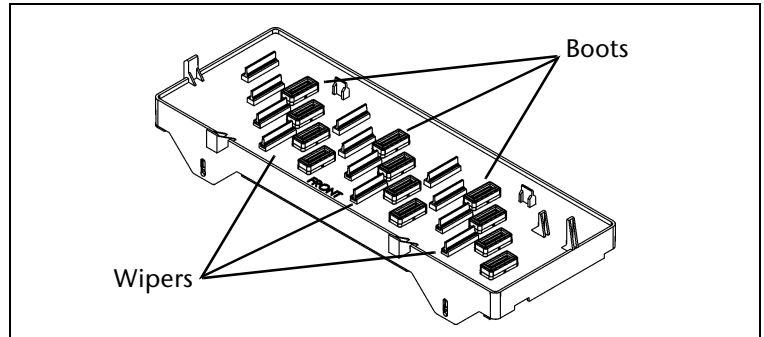
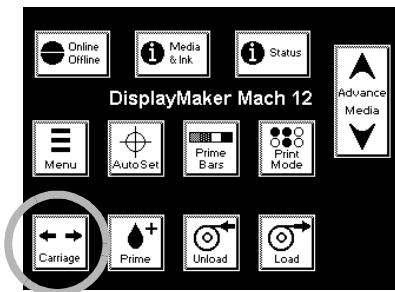

Fig. 5-1. Service station parts



Caution To avoid contaminating the ink, keep water away from the boots and boot holders during this procedure.



1. From the Front Page screen on the control panel, press the Carriage key.
This moves the printhead carriage out to the center of the platen.
2. Open the service station access door.
3. Reach inside the right endcap (behind the control panel) and lift the service station out of the printer.
Hold the service station level to avoid spilling any ink that may be present.
4. Hold the service station with the wipers under a stream of water.
Rinse as much ink as possible from the wipers.

5. Blot any remaining water from the service station with a clean, lint-free cloth.

To avoid contaminating the ink, be sure to dry all water from the boots and boot holders.

6. Replace the service station into the printer.
7. Close the service station access door.
8. On the Front Page screen, press the Carriage key.
The printhead carriage returns to the service station.

Printing Prime Bars

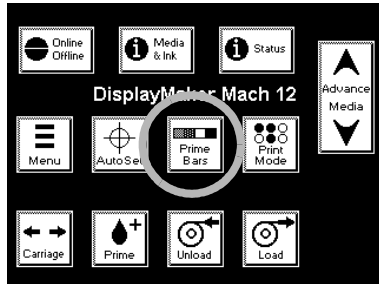

Maintenance interval: as needed.

To keep the printhead jets firing properly, you can print solid blocks of ink from each printhead. By inspecting these prime bars for blank bands, you can also do a quick check for nonfiring and deflected jets. Based on this quick test, you may want to proceed to more detailed jet tests (see Chapter 4, Calibrating the Printer, for instructions).

1. From the control panel Front Page screen, press the Prime Bars key.
2. Choose Quick Prime Bars or Detailed Prime Bars.

Choose Quick Prime Bars for most primes, or Detailed Prime Bars when you want to locate individual missing jets that AutoSet may have missed, so you can map them manually under **Calibrate Printer - Manual Calibrations - Manual Jet Mapping** (see “Manual Jet Mapping” on page 4-16 for instructions).

The control panel displays a prompt asking you to enter the total width of the prime bar pattern you wish to print.

3. Enter a width for the prime bar pattern by pressing the ▼ and ▲ keys.
4. Press the ► (Proceed) key to continue.

The printer prints the prime bar pattern.

Manual Priming

Maintenance interval: as needed.

If you discover that an excessive number of jets are out on a printhead (after cleaning or printing the prime bars or other test), you can attempt to recover jets by performing a manual prime.

This procedure requires a special priming bulb, included with the printer. Each prime will expel approximately 1 ml of ink. To keep ink counting as accurate as possible, you will report the number of primes to the printer via the control panel.

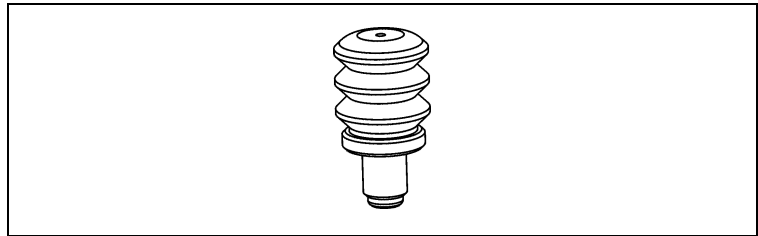
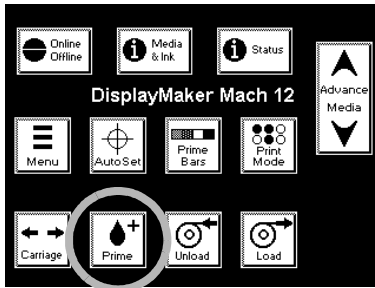

Fig. 5-2. Manual prime bulb



1. From the control panel Front Page screen, press the Prime key.
2. Open the service station access door.
3. Insert the priming bulb into one of the priming access holes in the top cover of the carriage.

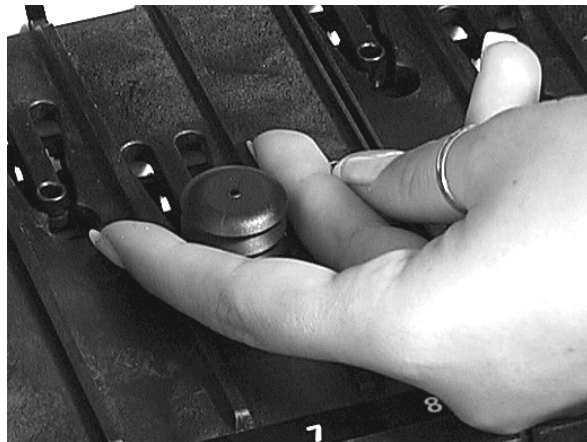

Fig. 5-3. Inserting the priming bulb

4. Depress and release the priming bulb to prime the printhead.
5. On the control panel, report how many primes you performed.
6. Repeat steps 3 and 4 for any other printheads needing manual priming.
7. Close the service station access door.
8. Press the ► key to return the carriage to the home position.

Cleaning the Top Cover

Maintenance interval: as needed.

The printer's top cover is designed to protect you from the printhead when it is moving (it moves very fast during printing) and reduce noise, while providing an unobstructed view of the print area.

Careful cleaning when needed, according to the following guidelines, will preserve the cover's appearance:

- ◆ Do not use cleaners that contain ammonia (such as glass cleaner) or alcohol.
- ◆ Do not use paper towels or abrasive cloths or pads.
- ◆ Use only 100% cotton cloths and mild detergents (such as dishwashing liquid) and water, or cleaners and polishes developed for plastics (such as NOVUS Plastic Polishes, see your ColorSpan reseller for details). Blot dry; wiping could scratch the surface and create an electrostatic charge.

Purging the Printheads

Maintenance Interval: as needed.

Since removing, purging, replacing, and recalibrating a printhead is a time-consuming process, purge all printheads currently installed in the carriage in a single session.

To perform this process, you will need the purge clip, included with the printer, and paper toweling to blot the ink that will come out of the printhead during purging. You may also want to wear gloves to avoid staining them with ink.

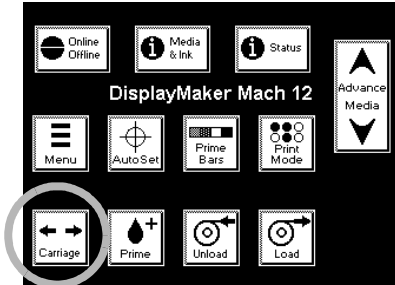

1. Return to the Front Page screen.
2. From the control panel Front Page screen, press the Carriage key.

The printhead carriage moves to the access position.

Begin with the printhead in position 1.

3. Open the printer's top cover.
4. Open the carriage cover.
5. Remove the printhead from the carriage.
6. Depress the lock levers to unlock the printhead assembly, and swing it up to expose the bottom of the carriage.
7. Disconnect the ink tube from its attachment clips on the carriage.
8. Insert the printhead as shown into the purge clip.

Hold the printhead so its jet orifice plate points up.

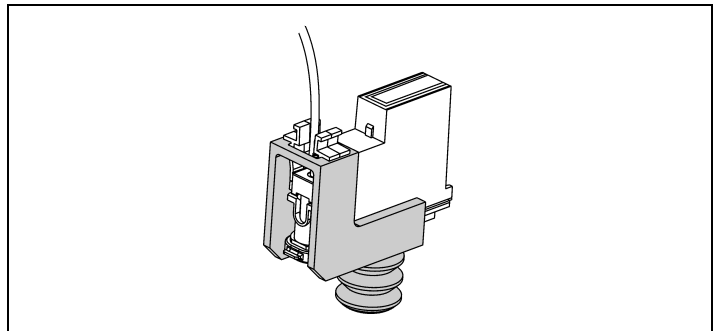

Fig. 5-4. Printhead installed in the purge clip

9. Connect the ink tube to the ink inlet on the printhead.

10. Gently press and hold the purge bulb until ink emerges from the jet orifice plate with no air bubbles.

Be sure that the hole on the end of the purge bulb is sealed with your finger as you press. Blot the ink with a paper towel, but do not wipe (wiping could clog the ink jets).

11. Disconnect the ink tube from the printhead.
12. Reconnect the ink tube its clips and connector on the printhead carriage.

Match the number label on each ink tube to the number molded into the plastic holder assembly. The positions are numbered 1-12, from left to right.

13. Swing the printhead assembly down into the printing position, and push the printhead assembly down into position until it engages the lock levers with a click.
14. Replace the printhead into its position in the carriage.
15. Snap the carriage cover closed.
16. Repeat steps 5 through 15 for each printhead.
17. Close the printer's top cover.
18. From the control panel Front Page screen, press the Carriage key.
The printhead carriage returns to the home position.
19. From the Front Page screen, press the AutoSet key to perform an AutoSet calibration.

Cleaning the Encoder

Maintenance interval: at Maintenance Clock Alarm.

The encoder strip allows the printer to precisely locate the print-head carriage across the width of the platen. If the encoder becomes dirty with paper dust or ink, the printer cannot print accurately, and print quality will suffer.

The encoder strip **①** is a clear plastic strip, imprinted with a precision encoding pattern, and mounted horizontally along the rail **②**. To clean the encoder strip, use a can of compressed air, sold at camera or graphic supply stores, to blow dust and other particles from it.

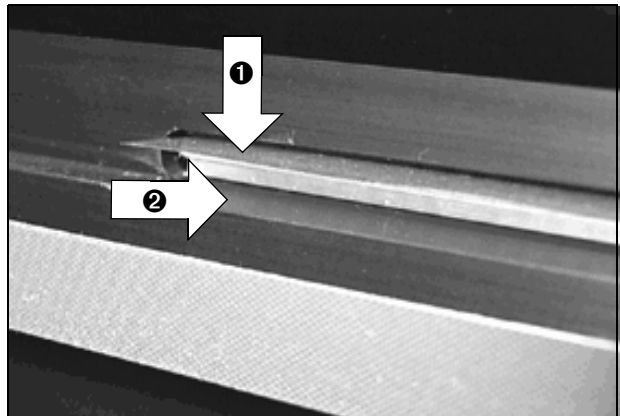

Fig. 5-5. Encoder and rail

Cleaning the Carriage Rail

Maintenance interval: at Maintenance Clock Alarm.

The carriage rail carries the printhead carriage across the width of the platen. If dust or other particles accumulate on the rail, the material could accumulate on the carriage wheels (bearings) and cause banding in printed output or noisy carriage motion.

To clean the rail, wipe it with a water-moistened cloth or paper towel. Be sure to remove any excess water from the rail before resuming printing.

APPENDIX A

Technical Specifications

This chapter lists the printer's specifications and information about ordering supplies.

Specifications

General

Dimensions (Assembled)	Depth: 31 inches (78.7 cm) Height: 57.3 inches (145.5 cm) Width: 132 inches (335.3 cm), 72-inch model 120 inches (304.8 cm), 60-inch model 102 inches (259.1 cm), 42-inch model
Weight (Assembled)	72-inch model: 335 lbs (152 kg) 60-inch model: 310 lbs (140.9 kg) 42-inch model: 280 lbs (127.3 kg)
Electrical Power	Three printer components have power requirements: printer, primary dryer, and secondary dryer.

Printer

- ◆ Power used: 100-120 VAC, 4.0 Amps (nominal, $\pm 10\%$), 50-60 Hz, **OR** 200-240 VAC, 2.0 Amps (nominal, $\pm 10\%$), 50-60 Hz
- ◆ Required circuit: 100-120 VAC **OR** 200-240 VAC, 15 Amps, with NEMA 5-15R wall receptacle (U.S./Japan) or CEE 7/7 (Europe) receptacle, or Hong Kong or China standard receptacle with included adapter plug.

The printer power inlet may be connected to either of the listed circuits, using the supplied power cord and (if necessary) country adapter plug. The printer's power supply automatically senses and switches to accept the voltage range being supplied.

**Electrical Power
(continued)****Primary Dryer (optional)**

- ◆ Power used: 200-240 VAC, 16 Amps maximum when operating, 50-60 Hz
- ◆ Required circuit: 200-240 VAC, 20 Amps, with NEMA L6-20R (United States and Japan) or CEE 7/7 (Europe) receptacle

If your building receives power from a standard U.S. 208 VAC/60 Hz/three-phase supply, note that the heater will use only one of the three phases. This means that your building's three-phase power transformer will have an unbalanced load. Check with your electrician to verify that your building has sufficient capacity for this unbalanced load.

If the supplied power cord is connected, the heater operates during printing, and may be turned on or off at the printer control panel. If not connected, this heater will not operate, but the dryer fans will still operate when activated.

Secondary Dryer (optional)

- ◆ Power used: 200-240 VAC, 12.0 Amps maximum when operating, 50-60 Hz
- ◆ Required circuit: 200-240 VAC, 15 Amps, with NEMA 6-15R (United States and Japan) or CEE 7/7 (Europe) receptacle

If the supplied power cord is connected, this heater operates during printing, and may be turned on or off at the printer control panel. If not connected, this heater will not operate, but the dryer fans will still operate when activated.

Temperature

Storage: 0–120° F (-17–49° C)
Operating: 60–90° F (16–32° C)

**Relative
Humidity**

Storage: 10–80%, non-condensing
Operating: 10–80%, non-condensing,
30–60% optimum
Built-in humidity sensing automatically adjusts printing speed to ensure adequate drying for the combination of media and ink selected

Approvals

Safety: UL, c-UL, CE
Emissions: FCC-A, CE, VCCI-1
Immunity: CE

Performance

Humidity Compensation	Slows printing in high-humidity environments (within specifications) to ensure complete drying.
Maximum Print Width	72 inches (182.0 cm), 71.5 inches (181.6 cm) image width 60 inches (181.6 cm), 59.5 inches (151.1 cm) image width 42 inches (106.7 cm), 41.5 inches (105.4 cm) image width

Print Modes

Mode	Color Set	Print Speed	Resolution
Economy	1 x CMYK	50-200 ft ² /hr.	600 dpi
Economy	2 x CMYK	100-400 ft ² /hr.	600 dpi
HiRes	1 x C2M2YK	50-200 ft ² /hr.	1200 dpi apparent
HiRes	2 x C2M2YK	100-400 ft ² /hr.	1200 dpi apparent
Film Quality	1 x C3M3YK	50-200 ft ² /hr.	1800 dpi apparent

Supported Ink and Media

Consult MacDermid ColorSpan or your MacDermid ColorSpan representative for an updated listing of supported ink and media.

APPENDIX B

Troubleshooting

This appendix explains how to prevent and diagnose printing problems and provides information about getting help from ColorSpan.

For other software-specific troubleshooting procedures, refer to your application software documentation or the other ColorSpan documentation listed on page vi of this manual.

If your printer is connected to a non-ColorSpan RIP or print server, refer to the accompanying third-party documentation.

Troubleshooting Checklist

Before you troubleshoot your printer, make sure that it is properly installed as described in Chapter 1, Getting Started.

Follow the steps in this checklist to isolate and resolve printing problems.

1. Does the printer's power come ON?

YES: Go to question 2.

NO: The following could be the problem:

- ◆ The power cable may not be plugged into an electrical outlet.
- ◆ If the printer is plugged into a surge protector, the surge protector may not be connected to power, or it may be switched off.

2. Did the start-up sequence of the control panel end by displaying a Ready (status) screen similar to the one shown in Fig. 2-1 on page 2-2?

YES: Go to question 3.

NO: The following could be the problem:

- ◆ There may be a hardware problem with the printer's internal components. Follow the diagnostic routine on the control panel to determine the problem. Call MacDermid ColorSpan Technical Services as directed by the control panel.

3. Can you send a file from the print server to the printer?

YES: Go to question 4.

NO: The following could be the problem:

- ◆ The cable may not be securely connected between the print server and the printer. Refer to the server's documentation for more information.
- ◆ The cable may be connected to the wrong port on the print server. Refer to the server's documentation for more information.

4. Can you send (print or download) a document from a client computer to the server?

YES: Go to question 5.

NO: The following could be the problem:

- ◆ The connection from the client to the local area network may not be configured correctly. See your system administrator for assistance.

- ◆ The cable between your computer or network and the print server may not be securely connected at both ends. Refer to the print server manual for more information.
 - ◆ Your computer may not be working properly. Run an application that you know works correctly and print to be sure.
 - ◆ The computer's port may not be working properly. Print to another output device that you know works correctly (and is not connected to the print server) to check this.
 - ◆ There may be another error condition reported by the print server.
5. Is the print quality good?

YES: Then the problem is not covered in this checklist. Contact MacDermid ColorSpan Technical Services.

NO: The following could be the problem:

- ◆ The printer may need to be calibrated. See Chapter 4, *Calibrating the Printer*, for instructions.
- ◆ One or more ink jets may be clogged or not firing. See "Cleaning Ink Jets" on page 5-3 for instructions.
- ◆ If the print head is striking the media, check how the media is tracking from the supply spool to the takeup spool. The sides of the media should be parallel to the sides of the printer, with no wrinkling or buckling. If necessary, reload the media. See "Loading Media" on page 3-24 for instructions.
- ◆ Verify that the print head carriage is at the proper height. See "Print Settings" on page 2-11 for instructions.

Diagnostics

The printer includes a series of self-diagnostic tests designed to help MacDermid ColorSpan Technical Services solve printer hardware problems. If one of the tests encounters an error, and error message appears, which includes:

- ◆ Error code - always write down this code for future reference by MacDermid ColorSpan Technical Services.
- ◆ Brief description of the error
- ◆ A series of buttons that allow you to respond to the error. In some cases, you can ignore the error or enter a further diagnostic routine. In other cases, you must restart the printer.

During the course of operating the printer, another class of error messages may appear on the control panel. The ATTN (Attention) key blinks on the Ready or Front Page screen when the printer detects an error condition, or potential error condition. When you press this button, the panel displays one or more messages of the following types:

- ◆ **Warnings** — the printer has detected a condition that, if left unaddressed, could result in substandard prints or a condition that will require an action before printing can continue. Any action on your part is optional.
- ◆ **Actions** — the printer has detected an error condition that stopped printing or will prevent printing from starting. You must correct the error before the printer will be ready to print.

The following table describes the Actions and Warnings in detail. The cross-referenced page numbers refer to this manual.

Table B-1. Actions and Warnings

Code, Message	Cause	Recovery
(CA) Carriage		
A-CA-1 - Carriage Rotation Sensor	Carriage is not locked into printing position.	Rotate the carriage down into locked position.
(IS) Ink Sensing		
A-IS-1 through A-IS-12 - Module Out of Ink, Slot # <i>n</i>	Ink reservoir <i>n</i> is out of ink.	Replace ink reservoir.
A-IS-13 through A-IS-24 - Printhead/Module Mismatch, Slot # <i>n</i>	Color/type in printhead and module <i>n</i> do not match.	Ensure that color & type match in printhead & module.
A-IS-25 through A-IS-36 - Missing Module/Printhead, Slot # <i>n</i>	Either module or printhead <i>n</i> is not detected.	Ensure that module and printhead are installed.
A-IS-37 - No Print Mode Selected	Print mode incomplete or not specified.	Press Print Mode key on control panel (page 3-7).
W-IS-1 through W-IS-12 - Low Ink, Slot # <i>n</i>	Ink reservoir <i>n</i> has about 50 ml of ink remaining.	Replace the ink reservoir soon.
(MC) Maintenance Clock		
W-MC-1 - Preventive Maint. Clock Alarm	Encoder strip and service station need cleaning.	Clean encoder strip and service station.
(MD) Media Drive		
A-MD-1 - Media Advance Stalled	The media drive motor has stalled.	Check supply spool for binding, motor for failure.
W-MD-1 - Index Sensor Not Detecting Index	Media drive cannot detect index pulse.	Clean or replace media drive sensor.
W-MD-2 - Media Advance Turn-around Time Exceed	Media is taking too long to advance.	Check supply spool for binding.
W-MD-3 - Media Advance Data Warning	Media advance needs calibration.	Run Media Advance Calibration (service menu).

Table B-1. Actions and Warnings

W-MD-4 Media Advance/Drive Too Slow	Media advance motor is too slow.	Determine the cause of the drag on the media advance servo motor. Listen for unusual noises coming from the grit roll shaft which might indicate sticking or binding. Advance the media with a supply loop in the media supply to eliminate media supply spool tension problems. As a last resort, disengage the motor from the grit roll shaft gear and attempt a media advance. The motor encoder will still report that the media is moving, and with no load the motor should easily reach the desired speed.
(MS) Media Sensing		
A-MS-1 - Media Too Thick at Load	The media you loaded is too thick.	Reload with a media less than 0.125 inches thick.
A-MS-2 - Media Thickness Increased	The media being printed is too thick.	Reload with a media less than 0.125 inches thick.
A-MS-3 - Media Too Far Left/Right	Media is loaded too far to the left or right.	Reload the media; align right edge to reference mark.
A-MS-4 - Media Out	There is no media loaded.	Load media.
A-MS-5 - Media Too Narrow	Media is not wide enough for printing.	Load media that is at least 24 inches wide.
A-MS-6 - Media Too Wide	Media is too wide for printing.	Use narrower media (page A-4).
W-MS-1 - Media Low	Less than 10 feet (3 meters) of media remains.	Load media or adjust Media Remaining value at panel (page 3-24).
W-MS-2 - Non-Standard Media Width	Media loaded may cause head strike.	Continue printing or replace media.
W-MS-3 - Media End Not Detected During Unload	The Unload function cannot find end of media.	Cut media prior to Unload, or do not use Unload.
(PC) Printing Calibrations		
A-PC-1 - Too Many Jets Mapped Out	Too many missing jets could be replaced.	Prime/clean printheads (page 5-10), or increase number of passes (page 3-7).
W-PC-1 - Printhead Removed - Recalibrate	A printhead was repositioned.	Run AutoSet (page 2-7).
W-PC-2 - Media Replaced - Recalibrate	Media caliper may need to be remeasured.	Run AutoSet if media type was changed (page 2-7).

Table B-1. Actions and Warnings

W-PC-3 - Head Height Changed - Recalibrate	Change in head height has invalidated calibration.	Run AutoSet (page 2-7).
W-PC-4 - AutoJet - Jets Not Mapped Out	Not all missing jets could be replaced.	Prime/clean printheads (page 5-3), or increase number of passes (page 3-7).
(PD) Primer Door		
A-PD-1 - Door Opened, Prime Not Selected	The primer door is open.	Close the primer door.
(PG) Purge		
W-PG-1 - Pens Require Purge	The printheads should be purged.	Purge all printheads (page 5-11).
(SC) System Calibrations		
W-SC-1 - Media Adv. Run Out Not Calibrated	Calibration was reset or not performed.	Calibrate media advance (page 4-4).
W-SC-2 - White Point Not Calibrated	Calibration was reset or not performed.	Calibrate white point (page 2-17).
W-SC-3 - Media Thickness Sensor Not Calibrated	Calibration was reset or not performed.	Calibrate media sensor (page 2-17).
W-SC-4 - Head Height Not Calibrated	Calibration was reset or not performed.	Calibrate head height (page 2-17).
W-SC-5 - Printer Length Not Known	Calibration was reset or not performed.	Calibrate printer length by restarting printer.
(SM) System		
A-SM-1 - Printer Not Imprinted	Defective electronics assembly.	Call service provider for replacement electronics.
A-SM-2 - Release S/W Found Debug S/W	Defective software.	Call service provider for updated software.
(SS) Service Station		
W-SS-1 Service Station Tray Not Present	The service station is not installed, or it is installed too far to the right.	Install service station properly, or defeat service station sensor (page 1-13).
(TC) Top Cover		
A-TC-1 - Cover Open	The top cover is open.	Close the top cover.
(TU) Take Up		
A-TU-1 - Takeup Full	The media takeup spool is full.	Unload the takeup spool and reload media (page 3-24).

Table B-1. Actions and Warnings

A-TU-2 - Takeup Stall	The takeup motor has stalled.	Check for mechanical interference or binding, overloaded spool, out of balance spool, or failure in electronics or motor.
W-TU-1 - Takeup Nearly Full	The media takeup spool is almost full.	Unload the takeup spool and reload media (page 3-24).
W-TU-2 - Takeup Connected - Slipping	The media takeup core is slipping.	Reload the media (page 3-24).
W-TU-3 - Takeup not Loaded	Takeup Mode ON, but takeup spool is not loaded.	Load takeup (page 3-24) or turn Takeup Mode OFF (page 2-11).
(VN) VideoNet		
W-VN-1 - VideoNet not Connected	The printer cannot detect a print server.	Connect cable, turn on server, add printer to server.
(WP) White Point		
A-WP-1 - White Point Drift Too Large	Image sensor white point is invalid.	Clean LEDs and white point chip.
W-WP-1 - White Point Drift Detected	Image sensor white point is varying.	Clean LEDs and white point chip.
W-WP-2 - White Point Chip Missing	The image sensor white point chip cannot be seen.	Install/clean white point chip, or call Tech Support.

Banding

This is an explanation of the varieties of banding that may occur in output from the DisplayMaker Mach 12. The names applied to the banding here are also an attempt to generate a common language for describing and discussing types of banding.

Stitch Banding

“Stitch banding” results from inaccurate media advance and/or inaccurate head-to-head Y-axis registration. It can be described as regularly appearing bands, equally spaced according to the width of the print swath. Bands will be darker than the surrounding area if there is too little advance, or lighter than the surrounding area if there is too much advance.

To eliminate or reduce stitch banding:

1. Run an automatic or manual head-to-head calibration to correct any Y-offsets, especially if printing in 2x6 or 2x4 print modes.
2. Run a Media Advance Calibration to correct the media advance rate.
3. Re-run an automatic or manual head-to-head calibration to compensate for any Y-offset changes created by adjusting the media advance. Do this for both 1x and 2x print modes.
4. Run a test print to verify that banding has been eliminated. Repeat steps 2 and 3 if banding persists.

Edge Banding

Edge banding (or “spears”) results from either the service station configured for “Spit Only 30 seconds,” broken mechanical parts in the service station or carriage, or a missing service station. Without regular wiping, ink builds up on the printhead orifice plates during printing. As the liquid component of the ink evaporates, solids are left behind. New ink is jetted through the dried particles, which are picked up and deposited on the media, creating a dark band. If the build-up on the printhead is sufficiently heavy it will inhibit jetting and lead to light bands.

Prints will generally look good at the beginning, but will deteriorate as their printed length increases. Bands will be equally spaced down the length of the print. Banding will be most apparent at the outside left and right edges of the print and will taper off and possibly disappear altogether toward the center.

To reduce or eliminate edge banding:

1. Clean the printheads.
2. Confirm that the service station is installed.

3. Confirm that the service station algorithm under **Menu - Configure Printer - Printer Settings - Service Station** is set to **30 Second Spit & Wipe**.

Supply-Loop Banding

Supply-loop banding results from calibrating the printer with no supply loop present, but printing actual jobs *with* a supply loop. The tension on the media supply and the force necessary to pull media from the supply are factors in the media advance calibration. If calibration has been adjusted to compensate for a certain level of resistance from the supply, but printing takes place with a different resistance, then the output will show bands. The bands will be stitch bands, but they will disappear as soon as the supply loop has been taken up. A common description of the problem would be “The print looks fine except for the first 6 inches or so.”

It is also possible to have calibrated the advance with a supply loop; in this case, if the job begins with the loop also, then the job will be band-free initially but will start banding as soon as the loop is taken up. This situation is less likely to occur. If the calibration was performed with a loop, but printing begins with no loop, then the appearance will be stitch banding throughout the print.

To eliminate or reduce supply-loop banding:

1. Confirm that the printer was properly calibrated. Verify that the media advance calibration is performed with no supply loop, and that the calibration is accurate.
2. Ensure that there is no supply loop present at the start of the print job.
3. Reprint the same job with no supply loop present and confirm that the banding is eliminated.
4. Recommended: set **Configure Printer - Printer Options - Supply Loop to Prevent Supply Loop**. This will prevent media from reversing and creating a loop in the first place.

Texture Banding

Texture banding results from either unexpected changes in head height during printing, or failure to recalibrate after an intentional head height change. An accurately calibrated engine will produce random, equally distributed concentrations of dots, regardless of the intensity of coverage. A change to the head height without corresponding recalibration of bidirectional accuracy results in overall graininess and banding patterns.

To eliminate or reduce texture banding:

1. Reset the head height through **Menu - Service Printer - Calibrations - Head Height**. This returns the head to a known height in the event that it has moved unexpectedly.
2. Confirm the desired head height setting through **Menu - Configure Printer - Printer Settings- Head Height**.
3. Run AutoBidi and Auto Head-to-Head Calibration, or run AutoSet.

Swath Edge Banding

Swath edge banding occurs at the edges of print swaths, which are the strips of printed output created as the carriage moves across the page.

To eliminate or reduce swath edge banding:

1. Print in HQ mode. See “Selecting a Print Mode” on page 3-7.
2. If you are printing with two printheads per color, determine which color is causing the banding, and switch the printhead positions in the carriage.

Call MacDermid ColorSpan Technical Services at one of the numbers listed at the front of this manual.

Index

A

- Actions **B-5**
- Actions and warnings **2-16, B-5**
- Advance Media **2-7**
- ATTN (Attention) **2-8**
- Audible alarm **2-13**
- Auto Calibrations **2-10**
- AutoJet calibration **4-2**
- AutoSet calibration **1-21, 2-7, 4-2**
 - quality check mode **4-20**
- AutoSet summary **4-21**
- AutoTune scheduling **1-21, 2-10, 4-3**
 - quality check mode **4-20**

B

- Bidirectional registration **4-2, 4-7**

C

- Calibrating the printer **4-1**
- Calibration **2-10, 2-17, 4-1**
 - AutoJet **4-2**
 - AutoSet **1-21, 4-2**
 - AutoTune Scheduling **1-21**
 - bidirectional **4-2, 4-7**
 - color **4-23**
 - head-to-head **4-2, 4-10**
 - manual jet mapping **4-13**
 - quality check mode **4-20**
- Calibration summary **2-10, 4-21**
- Carriage **1-18**
- Carriage access function **2-8**
- Carriage rail
 - cleaning **5-14**
- Cleaning
 - carriage rail **5-14**
 - encoder strip **5-13**

- printheads **5-10**
 - service station **5-5**
- Color calibration **4-23**
- Color map **3-5**
- Color set
 - defined **3-2**
- Control panel
 - actions **2-3**
 - actions and warnings **2-16**
 - ATTN key **2-3**
 - audible alarm **2-13**
 - Auto Calibration **2-10**
 - AutoTune **2-10**
 - calibration summary **2-10, 4-21**
 - changes **2-3**
 - dryer **2-13**
 - drying delay **2-12**
 - error history **2-16**
 - Front Page screen **2-2, 2-5**
 - gutters **2-11**
 - head height **2-12**
 - home head **2-17**
 - jet status lines **4-18**
 - log error history **2-16**
 - log head registration data **4-21**
 - log jet data **4-21**
 - manual calibration **2-10**
 - margins **2-12**
 - measure platen **2-15**
 - media supply loop **2-14**
 - menu **2-2**
 - navigation keys **2-9**
 - print mode **3-7**
 - print position **2-14**
 - print settings **2-11**
 - print white space **2-13**
 - printer configuration **2-11**
 - printer options **2-13**
 - quality check mode **2-13**
 - Ready screen **2-2**
 - reset all defaults **2-15**
 - restore all defaults **2-15**
 - service printer **2-16**
 - service station **2-12**
 - service station spits **2-13**

- service tests **2-16**
- space between prints **2-12**
- SS overspray delay **2-13**
- takeup direction **2-11**
- units **2-12**
- user assistance **2-3**
- user diagnostics **2-16**
- vacuum control **2-11**
- warnings **2-3**
- zero platen width **2-15**
- zero registration data **4-18**

Cutting media **3-32**

D

- Diagnostics **B-4**
- Dryer **1-21, 2-13, 3-31**
- Drying delay **2-12**

E

- Electrical requirements **1-2**
- Encoder strip
 - cleaning **5-13**
- Environmental requirements **1-2**
- Error history **2-16**
- Error messages
 - actions and warnings **B-5**

F

- FCC statement **v**
- Front Page screen **2-2, 2-5**

G

- Gutters **2-11**

H

- Head height **2-12**
- Head-to-head registration **4-2, 4-10**
- High quality (HQ) mode **3-2**
- Home head **2-17**
- Hot swapping **3-18**
- HQ mode
 - defined **3-2**
- Humidity sensor **1-21**

I

- Ink
 - color map **3-5**
 - color set defined **3-2**
 - hot swapping **3-18**
 - ink tube number label **3-5**
 - ink type label **3-5**
 - installation **3-12**
 - replacing **3-17, 3-18**
 - spares **3-6**
- Ink dryer **3-31**
- Ink module **3-4**
 - replacing **3-17, 3-18**
- Ink tube **3-4**
 - replacing **3-20**
- Ink tube number label **3-5**
- Ink type label **3-5**
- Installation
 - ink **3-12**
 - media **3-24**
 - printer **1-5**

J

Jet replacement 3-2
Jet status lines 4-18, 5-4

L

Linearization 1-21, 4-23
Loading media 2-8, 3-24
Log error history 2-16
Log head registration data 4-21
Log jet data 4-21

M

Manual calibration 2-10
Manual jet mapping 4-13
Margins 2-12
Measure platen 2-15
Media
 cutting 3-32
 loading 2-8, 3-24
 unloading 2-8, 3-32
Media dryer 3-31
Media Feed calibration 4-4
Media sensor 1-18
 disable 2-18
Media spool 3-24
Media supply loop 2-14
Media width 1-21
Menu 2-2
Menu tree 2-19
Modular ink delivery system 1-21

O

Ordering supplies A-5

P

Parts list 1-6
Parts overview 1-17
Passes 3-2
 defined 3-2
Periodic maintenance 5-2
Prime access door 1-18
Prime bars 2-7, 5-7
Priming 1-21, 2-8, 5-7
 manual 5-8
Print mode 3-2, 3-7
Print passes
 defined 3-2
Print position 2-14
Print settings 2-11
Print white space 2-13
Printer configuration 2-11
Printer options 2-13
Printheads 3-4
 cleaning 5-10
 replacing 3-19
Printing
 jet replacement 3-2
 passes 3-2
Purging 1-21, 5-11

Q

Quality check mode 2-13, 4-20

R

Ready screen 2-2
Regulatory statements v
Related manuals vii
Relative humidity sensor 1-21
Reset All Defaults 2-15
Restore all defaults 2-15

S

Safety warnings 1-4, 1-5, 1-9, 1-13
Service printer 2-16
Service station 2-12
 cleaning 5-5
Service station spits 2-13
Service tests 2-16
Space between prints 2-12
Spare ink 3-6
Specifications A-1
SS Overspray Delay 2-13
Supplies and accessories A-5
Supply loop 2-14, B-10

T

Takeup direction 2-11
Takeup system 1-21
 options 3-30
Technical Support B-12
Top cover 1-18
Troubleshooting B-1

U

Units 2-12

Unloading media 2-8, 3-32
Unpacking and assembly 1-5
User diagnostics 2-16

V

Vacuum control 2-11
Variable Mode Printing 3-2

W

Warnings 1-4, 1-5, 1-9, 1-13, B-5
Workflow overview 1-16

Z

Zero platen width 2-15
Zero registration data 4-18

